

Danish Quality Products

JB MEDICO

Suspension solutions for the healthcare sector



Orders can also be sent to
info@jbmedico.com

Product Catalog

Without prices 2018

Supplier to the Danish hospitals since 2004

CONTACTS

Jesper Abildskov Berg

Phone: +45 7020 5826

Mobil: +45 2868 5826

Area Sale Denmark and exports

E-mail: jb@jbmedico.com

Jørgen Hougaard

Nurse

Phone: +45 7020 5826

Area Sale: Denmark

E-mail: jh@jbmedico.com

Jan Haurum Kristensen

Phone: +45 7020 5826

Production & Construction

E-mail: jan@jbmedico.com

Mads Skytte

Phone: +45 7020 5826

Area Sales Manager

E-mail: ms@jbmedico.com

IV-Poles Glove Box Holder, Flat Screen Arm & Sliding Clamps

Hospital equipment manufactured in Denmark by skilled smiths/machine workers.

JB-Medico known for delivering fast, and at a fair price, we develop products in collaboration with our customers: you guarantee that they worked in the clinic and customised to your systems.

JB Medico has strived to make a difference in the industry in the design and advisory services of hygienic suspension solutions to the healthcare sector. Our focus areas are, therefore: Delivery time/Security, Quality, Design, Function and Flexibility.

Our vision is to develop improved hygiene and working environments for hospitals, laboratories, educational institutions and clinics.

The partnership with our excellent local manufacturers ensures that we can live up to our high-quality standards.

JB Medico is the first healthcare company in Europe to develop and produce "Ergonomic IT" in stainless steel.

90% of our products designed exclusively in Denmark.

Sliding Clamps

Bedside rails

Sharpsafe holder in stainless steel

We offer the highest standards of hygiene, quality, functionality and safety for all health professionals.

Our mission

Together with leading specialists, we ensure our customers the most qualitative, hygienic and flexible product programs for working environments in hospitals etc.

Made of necessity - designed to last - We hope you can enjoy our products

We reserve the right to make changes, errors and omissions in printed material.

All prices are excl. VAT & freight

Contents

Medical rail clamps5

 Scandinavia Standard for 10x30mm rails 5

 Rail clamps Extra Solid for heavy and long examination light..... 8

 EU DIN Standard for 10x25mm rails..... 9

Multibracket, turned upside down, fit from 16-41mm12

JBM BEDSIDE RAIL, HYGIENIC DESIGN19

 Bedside Rails and Accessories EU DIN 10x 25mm..... 21

FLAT SCREEN ARMS & ACCESSORIES STAINLESS STEEL.....25

 Gas assisted arm in a stainless steel..... 25

TABLET & IPAD- HOLDER/STAINLESS STEEL32

Soap and alcohol steel dispenser for 1.0 l bags and bottle35

 Drip trays and Soap Dispenser..... 38

Glove Box Holder & Accessories.....42

IV STANDS & IV POLES “ONE HAND”49

 IV poles accessories 58

 Pushing handle for IV stand/ IV pole..... 58

Oxygen & Gas cylinder holders60

Bracket for Sharps Containers, Electropolished Stainless Steel63

Wire baskets & wire products Electropolished Stainless Steel73

 Beakers and Catheter containers 75

 Various accessories..... 78

TUBING HOLDER79

MEDICAL RAIL CLAMPS

Scandinavia Standard for 10x30mm rails

	Description	P/N	RRP EUR
	<p>Slide clamp, wide model, locked using two socket screws. Aluminium (Anodised)</p> <p>Specifications: H: 61,5mm, W: 90mm, D: 25mm</p>	<p>JB 88-00-00</p> <p>MOQ 5 PCS.</p>	
	<p>Slide clamp, wide model, locked with one ball lock. Aluminium (Anodised)</p> <p>Specifications: H: 61,5mm, W: 90mm, D: 25mm</p>	<p>JB 103-00-00</p> <p>MOQ 5 PCS.</p>	
	<p>Slide clamp, wide model, locked with two ball locks. Aluminium (Anodised)</p> <p>Specifications: H: 61,5mm, W: 90mm, D: 25mm</p>	<p>JB 104-00-00</p> <p>MOQ 5 PCS.</p>	
	<p>Slide clamp, wide model, locked with two ball locks. Three pcs. Countersunk holes Ø6,6mm Aluminium (Anodised) "Prepared for suspension."</p> <p>Specifications: H: 61,5mm, W: 90mm, D: 25mm</p>	<p>JB 207-00-00</p> <p>MOQ 5 PCS.</p>	

Scandinavia Standard for 10x30mm rails

	Description	P/N	RRP EUR
	<p>Slide clamp, wide model, locked using two socket screws. Three pcs. Countersunk holes $\varnothing 6,6\text{mm}$</p> <p>"Prepared for suspension." Aluminium (Anodised)</p> <p>Specifications: H: 61,5mm, W: 90mm, D: 25mm</p>	<p>JB 206-00-00</p> <p>MOQ 5 PCS.</p>	
	<p>Slide clamp, wide model, locked with one ball lock. Three pcs. Countersunk holes $\varnothing 6,6\text{mm}$</p> <p>"Prepared for suspension." Aluminium (Anodised)</p> <p>Specifications: H: 61,5mm, W: 90mm, D: 25mm</p>	<p>JB 217-00-00</p> <p>MOQ 5 PCS.</p>	
	<p>Slide clamp half model, locked with one ball clasp, and a T-slot track</p> <p>Aluminium (Anodised)</p> <p>Specifications: H: 61.5mm W: 45mm D: 25mm</p>	<p>JB 120-00-00</p> <p>MOQ 5 PCS.</p>	
	<p>Slide clamp half model, locked with one ball clasp</p> <p>Aluminium (Anodised)</p> <p>Specifications: H: 61,5mm, W: 45mm, D: 25mm</p>	<p>JB 121-00-00</p> <p>MOQ 5 PCS.</p>	
	<p>Slide clamp half model, locked with one ball clasp (News)</p> <p>Countersunk $\varnothing 6,6\text{mm}$ holes</p> <p>Specifications: H: 61,5mm, W: 45mm, D: 25mm</p>	<p>JB 121-03-00</p> <p>MOQ 5 PCS.</p>	

Scandinavia Standard for 10x30mm rails

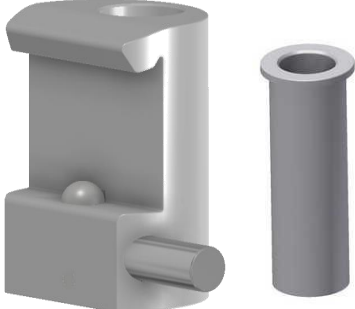
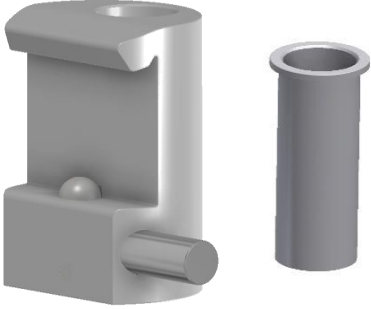
	Description	P/N	RRP EUR
	<p>Slide clamp for medical lamps with ball clasp, Ø18mm hole, and plastic bush with bush hole Ø9,6mm</p> <p>Aluminium (anodised)</p> <p>Specifications: H: 61.5mm W: 45mm D: 35mm</p>	<p>JB 126-09-06</p> <p>MOQ 5 PCS.</p>	
	<p>Slide clamp for medical lamps with ball clasp, Ø18mm hole, and plastic bush with bush hole Ø13mm</p> <p>Aluminium (anodised)</p> <p>Specifications: H: 61.5mm W: 45mm D: 35mm</p>	<p>JB 126-00-13</p> <p>MOQ 5 PCS.</p>	
	<p>Slide clamp for medical lamps with ball clasp, Ø18mm hole, and plastic bush with bush hole Ø16mm</p> <p>Aluminium (anodised)</p> <p>Specifications: H: 61.5mm W: 45mm D: 35mm</p>	<p>JB 126-00-16</p> <p>MOQ 5 PCS.</p>	
	<p>Slide clamp for medical lamps with ball clasp and Ø18mm hole</p> <p>Aluminium (anodised)</p> <p>Specifications: H: 61.5mm W: 45mm D: 35mm</p>	<p>JB 126-00-00</p> <p>MOQ 5 PCS.</p>	

Rail clamps Extra Solid for heavy and long examination light
Scandinavia Standard for 10x30mm rails

	Description	P/N	RRP EUR
	<p>Slide clamp, wide model, locked using two socket screws with three pcs. Countersunk Ø6,6mm holes With Fixing device, Ø18mm hole</p> <p>Three bush sizes purchased separately Handles purchased separately</p> <p>Specifications: H: 61,5mm, W: 90mm, D: 60,6mm</p>	<p>JB 206-03-18</p> <p>MOQ 2 PCS.</p>	<p>(News)</p>
	<p>Slide clamp, wide model with one-ball clasp and three pcs. countersunk Ø6,6mm holes With Fixing device, Ø18mm hole</p> <p>Three bush sizes purchased separately Handles purchased separately</p> <p>Specifications: H: 61,5mm, W: 90mm, D: 60,6mm</p>	<p>JB 217-03-18</p> <p>MOQ 2 PCS..</p>	<p>(News)</p>
	<p>Slide clamp, wide model with two-ball clasp and three pcs. countersunk Ø6,6mm holes With Fixing device, Ø18mm hole</p> <p>Three bush sizes purchased separately Handles purchased separately</p> <p>Specifications: H: 61,5mm, W: 90mm, D: 60,6mm</p>	<p>JB 207-03-18</p> <p>MOQ 2 PCS.</p>	<p>(News)</p>
	<p>Slide clamp half model, locked using two socket screws, three pcs. countersunk Ø6,6mm holes With the fixing device, Ø18mm hole</p> <p>Three bush sizes purchased separately Handles purchased separately</p> <p>Specifications: H: 61,5mm, W: 45mm, D: 60,6mm</p>	<p>JB 216-03-18</p> <p>MOQ 4 PCS.</p>	<p>(News)</p>

EU DIN Standard for 10x25mm rails

	Description	P/N	RRP EUR
	<p>Slide clamp half model, with one ball clasp and T-slot</p> <p>Specifications: H: 61.5mm W: 45mm D: 29mm Aluminium (anodised)</p>	<p>JB 146-00-00</p> <p>MOQ 5 PCS.</p>	
	<p>Slide clamp half model, with one ball clasp</p> <p>10mm x 25mm rail</p> <p>Specifications: H: 61.5mm W: 45mm D: 29mm Aluminium (anodised)</p>	<p>JB 147-00-00</p> <p>MOQ 5 PCS.</p>	
	<p>Slide clamp half model, with one ball clasp three pcs. countersunk Ø6,6mm holes</p> <p>"Prepared for suspension."</p> <p>Specifications: H: 61,5mm W: 45mm D: 29mm Aluminium (anodised)</p>	<p>JB 147-03-00</p> <p>MOQ 5 PCS.</p>	
	<p>Slide clamp, wide model, locked using two socket screws</p> <p>Specifications: H: 61,5mm, W: 90mm, D: 28,6mm Aluminium (anodised)</p>	<p>JB 143-00-00</p> <p>MOQ 5 PCS.</p>	
	<p>Slide clamp, wide model, locked using two socket screws with three pcs. countersunk Ø6,6mm holes</p> <p>"Prepared for suspension."</p> <p>Specifications: H: 61,5mm W: 90mm, D: 28,6mm</p>	<p>JB 143-03-00</p> <p>MOQ 5 PCS.</p>	





EU DIN Standard for 10x25mm rails

	Description	P/N	RRP EUR
	<p>Slide clamp, wide model With two ball clasp</p> <p>Specifications: H: 61,5mm W: 90mm D: 28,6mm Aluminium (anodised)</p>	<p>JB 144-00-00</p> <p>MOQ 5 PCS.</p>	
	<p>Slide clamp, wide model With two ball clasp and three pcs. countersunk \varnothing6,6mm holes</p> <p>Specifications: H: 61,5mm W: 90mm D: 28,6mm Aluminium (anodised)</p>	<p>JB 144-03-00</p> <p>MOQ 5 PCS.</p>	
	<p>Slide clamp, wide model With one ball clasp</p> <p>Specifications: H: 61,5mm W: 90mm D: 28,6mm Aluminium (anodised)</p>	<p>JB 145-00-00</p> <p>MOQ 5 PCS.</p>	
	<p>Slide clamp, wide model With one ball clasp and three pcs. Countersunk \varnothing6,6mm holes</p> <p>Specifications: H: 61,5mm W: 90mm D: 28,6mm Aluminium (anodised)</p>	<p>JB 145-03-00</p> <p>MOQ 5 PCS.</p>	

EU DIN Standard for 10x25mm rails**Rail clamps for medical lamps**

	Description	P/N	RRP EUR
	<p>Slide clamp for medical lamps with ball clasp and \varnothing18mm hole</p> <p>Specifications: H: 61.5mm W: 45mm D: 35mm Aluminium (anodised)</p>	<p>JB 339-00-18</p> <p>MOQ 5 PCS.</p>	
	<p>Slide clamp for medical lamps with ball clasp and \varnothing18mm hole With plastic bush hole size \varnothing9.6mm</p> <p>Specifications: H: 61.5mm W: 45mm D: 35mm Aluminium (anodised)</p>	<p>JB 339-09-06</p> <p>MOQ 5 PCS.</p>	
	<p>Slide clamp for medical lamps with ball clasp and \varnothing18mm hole With plastic bush hole size \varnothing13mm</p> <p>Specifications: H: 61.5mm W: 45mm D: 35mm Aluminium (anodised)</p>	<p>JB 339-00-13</p> <p>MOQ 5 PCS.</p>	
	<p>Slide clamp for medical lamps with ball clasp and \varnothing18mm hole With plastic bush hole size \varnothing16mm</p> <p>Specifications: H: 61.5mm W: 45mm D: 35mm Aluminium (anodised)</p>	<p>JB 339-00-16</p> <p>MOQ 5 PCS.</p>	

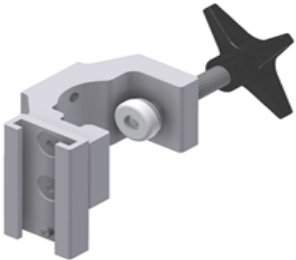
MULTIBRACKET, TURNED UPSIDE DOWN, FIT FROM 16-41MM

	Description	P/N	RRP EUR
	<p>Multibracket can be turned upside down, fit from 16-41mm</p> <p>Outer specifications: H: 36mm W: 51mm D: 134/96mm Weight: 230 g</p>	<p>JB 158-00-00</p> <p>MOQ 4 PCS.</p>	
	<p>Multibracket with 2 x Ø6 clearance holes That allows you to put together div. equipment, DIN rail and columns</p> <p>Outer specifications: H: 36mm W: 51mm D: 134/96mm Weight: 230 g</p>	<p>JB 158-00-05</p> <p>MOQ 4 PCS.</p>	
	<p>Double Multibracket for mounting, e.g. bed IV pole There are two pieces included</p> <p>Outer specifications: Weight: 460 g Material: Aluminum, RF steel & plastic</p>	<p>JB 158-06-05</p> <p>MOQ 2 PCS.</p>	
	<p>Multibracket with a T-slot bracket can be turned upside down, fit from 16-41mm</p> <p>Outer specifications: H: 36mm W: 51mm D: 134/96mm Weight: 230 g</p>	<p>JB 158-00-163</p> <p>MOQ 4 PCS.</p>	
	<p>Multibracket with 2xØ6 clearance holes Fit from 16-41mm With Fixing device, Ø18mm hole Three bush sizes purchased separately Handles purchased separately</p> <p>Outer specifications: H: 36mm W: 51mm D: 134/96mm Weight 460 g</p>	<p>JB 158-03-18</p> <p>MOQ 2 PCS.</p>	

Multibracket, turned upside down, fit from 16-41mm

Universal clamp for medical rails, round and square tubes, with eight drill holes on each side. JB Medico develops the multibracket in designing a universal bracket suitable for mounting on various medical rails, round and square tubes.

The bracket is in anodised aluminium with JB-threaded holes, which fits a variety of JB-Medico's other products.

Multibracket screwed on a rail. Clamped on columns, tables for hypodermic needles, on DIN EU 10x25mm rail profiles and glovebox holders etc.

Can be mounted both in horizontal and vertical position.

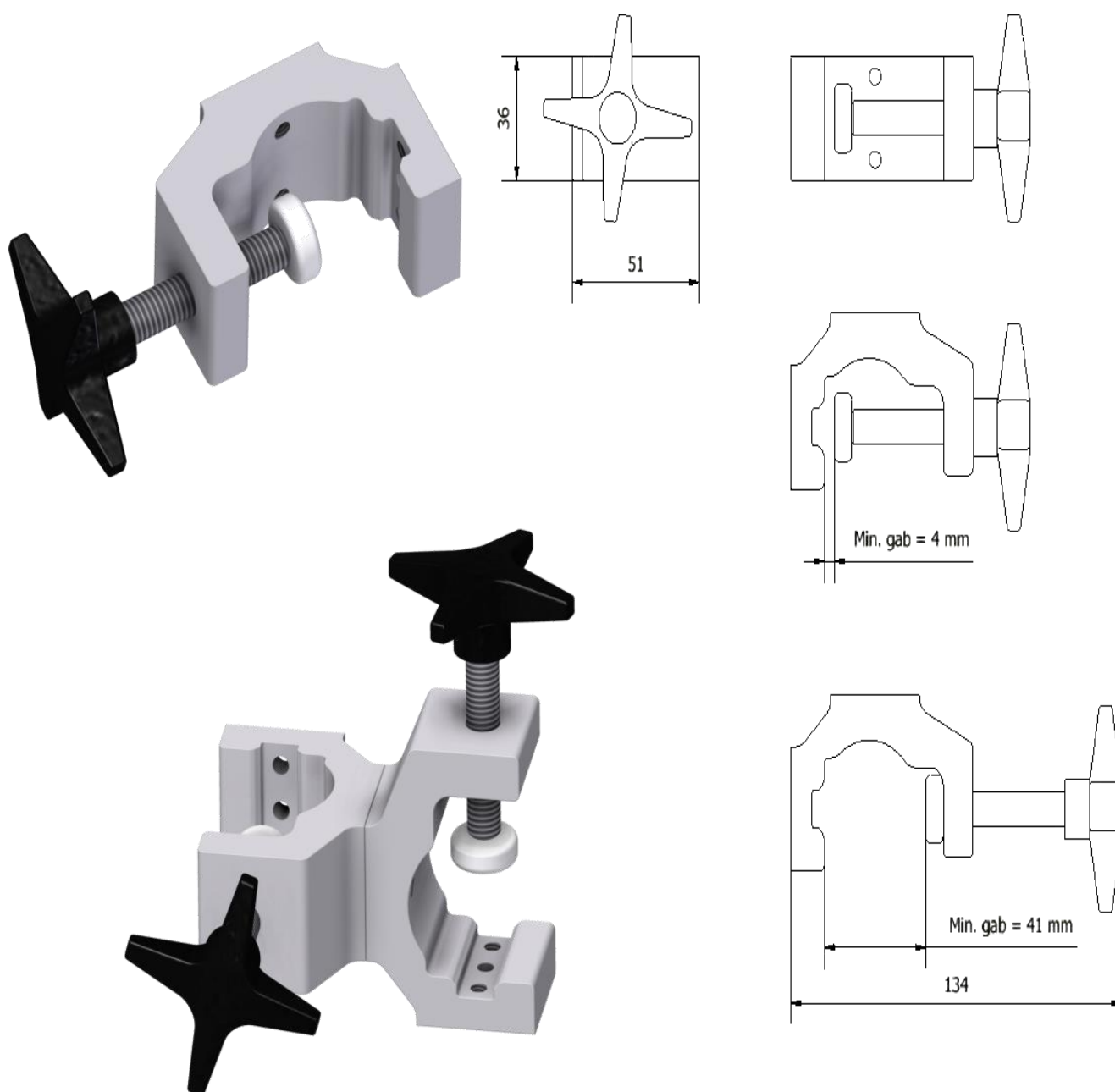

FIXING DEVICE FOR SLIDE CLAMPS AND MULTI BRACKETS, Ø25MM

P/N: JB 205-00-00 RRP **EUR:** 25,00

Aluminium (anodised)

Prepared for suspension

Weight: 0,4 kg

Ø25mm through hole without brass bushing

Specifications:

H: 61.5mm W: 45mm D: 35mm

Without brass bushing and adjustable stainless handle

Must be purchased as add-on products

Brass bushing: Ø25 x 20mm

P/N: JB 22-00-05 RRP **EUR:**

Stainless adjustable handle: M6 x 20mm

P/N: JB 94-00-00 RRP **EUR:**

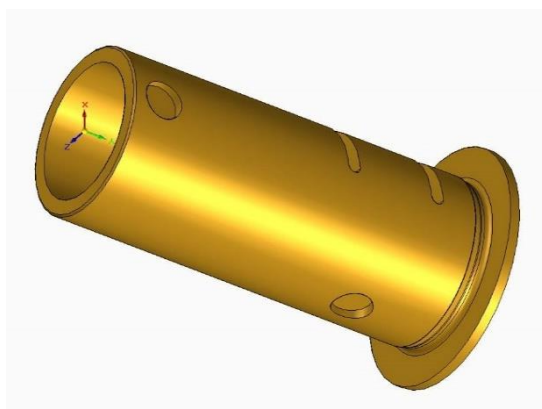

Fixing device for slide clamps and multi-brackets, Ø18mm

P/N: JB 205-00-18

Aluminium (anodised)

Ø18mm through hole without plastic bushing





Specifications:

H: 61.5mm W: 45mm D: 35mm

RRP EUR



Accessories

	Description	P/N	RRP EUR
	Plastic bush with hole size Ø9,6mm	JB 128-00-09	
	Plastic bush with hole size Ø13mm	JB 128-00-01	
	Plastic bush with hole size Ø16mm	JB 127-00-01	
	Stainless adjustable handle M6 x 20mm	JB 94-00-00	

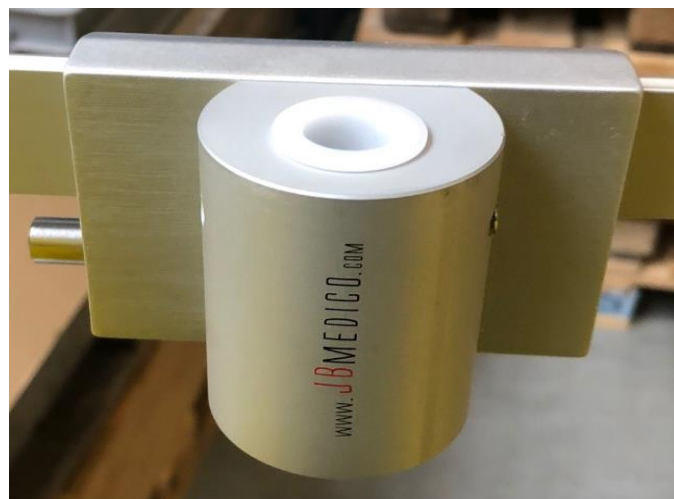

GALLERY FIXING DEVICE FOR SLIDE CLAMPS AND MULTI BRACKETS Ø25 & Ø18mm





Double Rail Clamp for 10x25mm DIN standard rails with a 4xM6 holes

P/N: JB 02-10-25

RRP EUR:

Specifications:

H: 40mm

W: 60mm

D: 40mm

Material: SST

Surface: Electro-polished

Weight: 0.3 kg

Available standard with umbraco screws

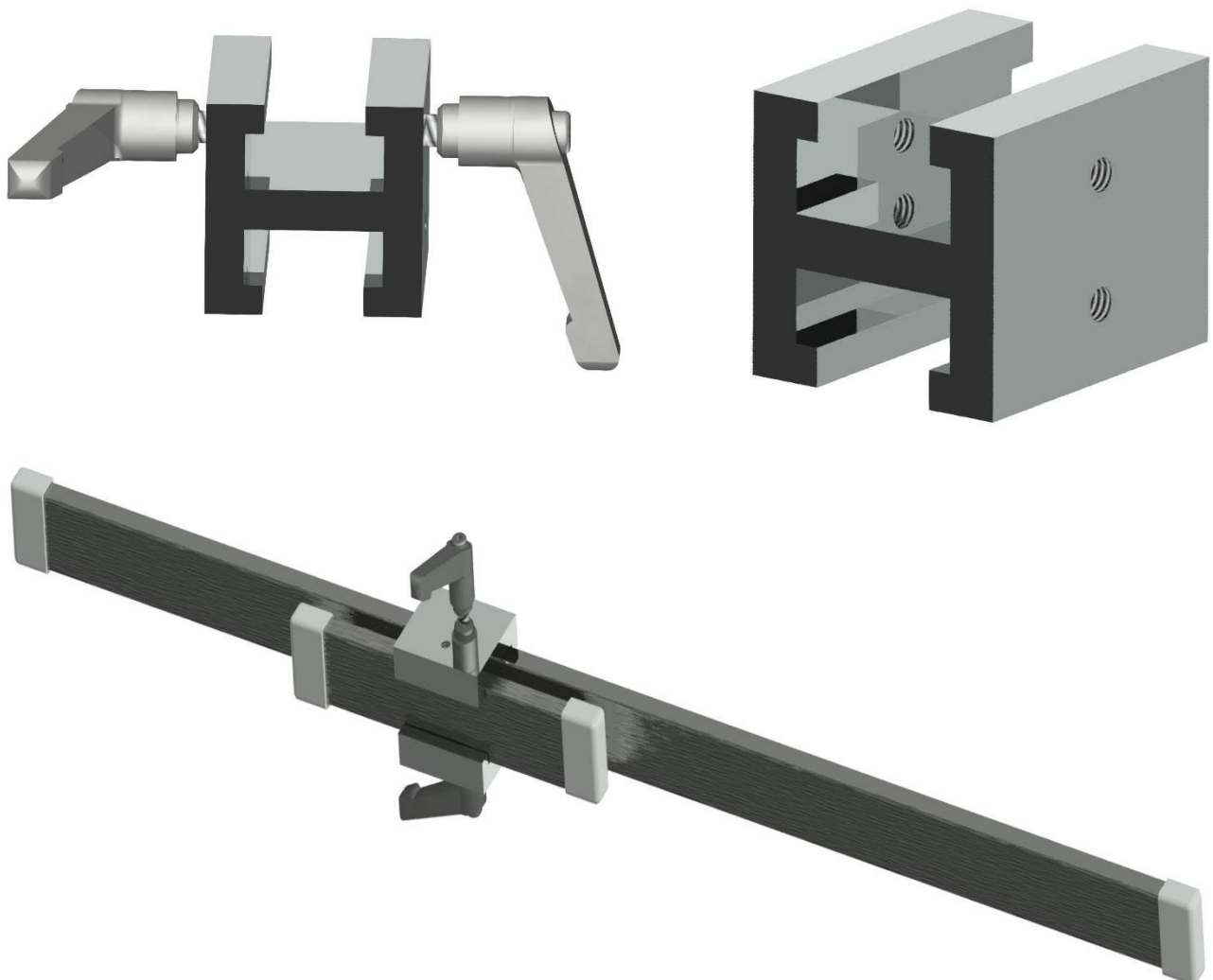

Stainless steel handle can be purchased (JB 94-00-00) 25,00 EUR

The claw can be used as an adapter to extend the operation-bed in a safe and sustainable manner





JBM BEDSIDE RAIL, HYGIENIC DESIGN

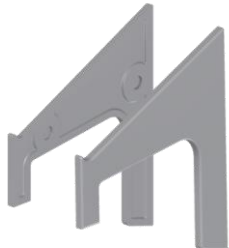

10x30mm SCANDINAVIAN STANDARD

	Description	P/N	RRP EUR
	<p>JBM Bedside Rail, Made in a hygienic design with greater depth to avoid conflict with cable trays, this enables the user to hang equipment, e.g.</p>	<p>JBM 100-01-06</p>	
	<p>Specifications: Material: Extruded aluminium Finish: Anodised/Painted Length: Standard 6 metre Weight: 3,8 kg per metre</p> <p>Additional costs are required for shortening</p>		
	<p>Mandrel for correctly mounting the cover plugs</p> 	<p>JB 101-00-00</p>	

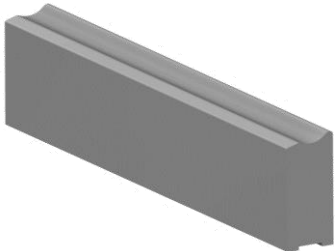
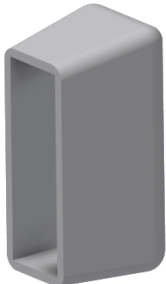
Bedside Rails and Accessories

	Description	P/N	RRP EUR
	<p>End caps for JBM rail</p> <p>Material: Plastic Colour: Gray</p>	<p>Right: JBM 100-01-07</p> <p>Left: JBM 100-01-08</p>	
	<p>Cover plugs for screw holes for JBM bedside rails</p> <p>MOQ 50 PCS. In a bag</p>	<p>JBM 100-01-10</p>	
	<p>Medical rail in aluminium Scandinavian standard 10x30mm</p> <p>Fits all our existing sliding clamps</p> <p>Specifications: W: 10mm H: 30mm Weight: 0,8kg per metre Material: Aluminium</p> <p>Additional costs are required for shortening Standard 6 metre</p>	<p>JB 234-00-01</p>	
	<p>End caps in grey plastic for solid 10 x 30mm rail.</p> <p>Only suitable for: Scandinavian Standard bedside rails</p>	<p>JB 248-00-00</p> <p>MOQ 10 PCS. in a bag</p>	

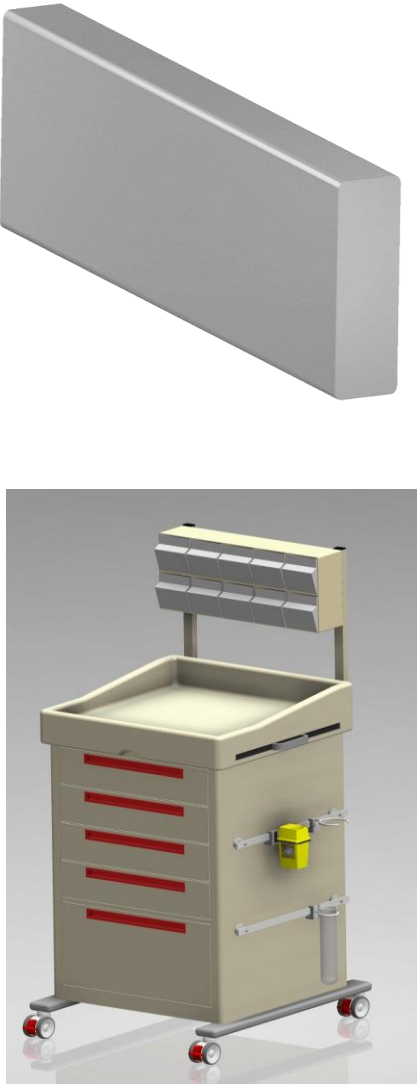
Bedside Rails and Accessories EU DIN 10x 25mm.

	Description	P/N	RRP EUR
	<p>JBM Massive DIN 10 x 25mm medical rail</p> <p>Specifications: Material: Extruded aluminium Finish: Anodised/Painted Length: Standard 6m. W: 10mm, H: 25mm Weight: 0.8 kg per Metre</p> <p>Additional costs are required for shortening Standard 6 metre</p>	<p>JB 252-00-00</p>	
	<p>Cover plugs for screw holes for JBM bedside rails.</p> <p>Material: Grey ABS plastic</p>	<p>JBM 100-01-10</p> <p>MOQ 50 PCS. In a bag</p>	
	<p>End caps in grey plastic for JBM EU. DIN 10x25mm rails Fit both the massive and hollow squared DIN 10x25mm profile</p>	<p>JB 249-00-00</p> <p>MOQ 10 PCS. In a bag</p>	

Bedside Rails and Accessories

	Description	P/N	RRP EUR
	Wall or equipment fittings for medical rails Material: Stainless steel Electro polished	JB 286-00-00 MOQ 10PCS. In a bag	
	Spacer to two types of wall rails, length 18mm Material: Stainless steel Electropolished	JB 286-00-18 MOQ 10 PCS. In a bag	
	Wall or equipment fittings for medical rails Material: Aluminium Finish: Anodised/Painted	JB 400-00-00 MOQ 10 PCS. In a bag	
	Spacer to two types of wall rails, length 18mm Material: Aluminium Finish: Anodised/Painted	JB 400-00-18 MOQ 10 PCS. In a bag	
	Cover plugs for screw holes for JBM bedside rails Material: Plastic	JBM 100-01-10 MOQ 50 PCS. In a bag	

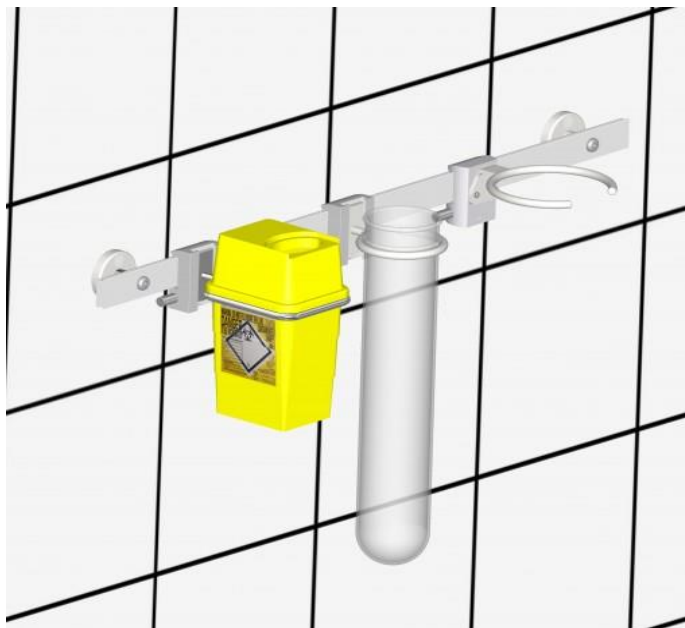
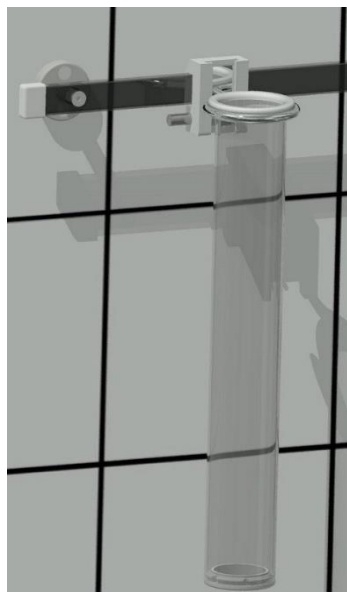

Bracket for protection of medical equipment rails etc.

It absorbs shocks from beds that accidentally collide with the rails

MOQ 4 PCS.

P/N JB 180-02-02 RRP EUR.

The bracket made of 5mm stainless steel

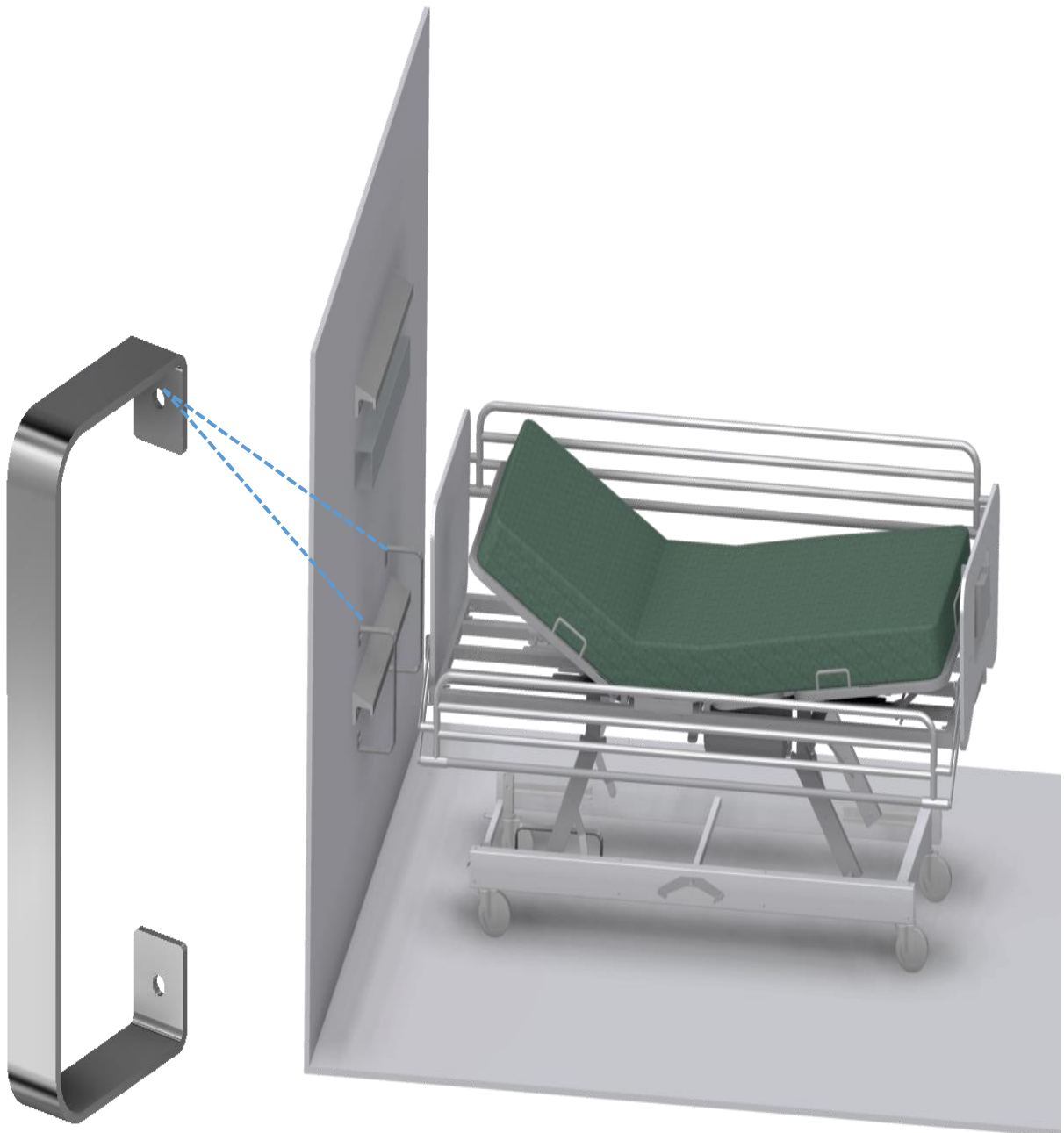

FLAT SCREEN ARMS & ACCESSORIES STAINLESS STEEL

Gas assisted arm in a stainless steel

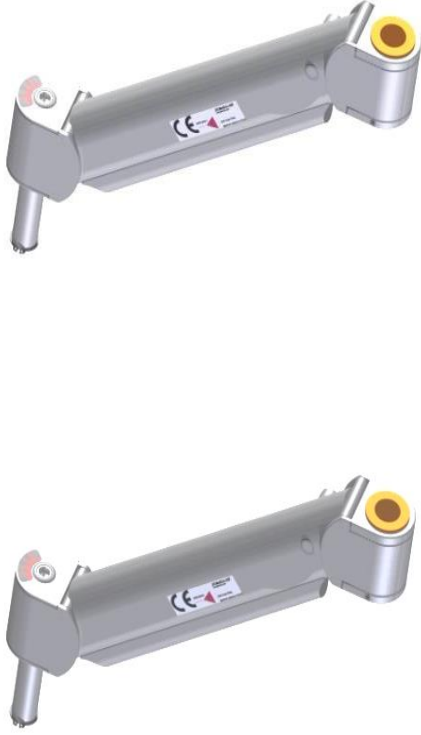
	Description	P/N	RRP EUR
	<p>Adjustable arm 2-8kg with an outer lock</p> <p>Adjustable arm 8-18 kg with an outer lock For mounting on a wall, table, ceiling, wall rails, equipment etc.</p>	<p>JB 21-00-00</p>	
	<p>All arms can potentially equalise Available with all necessary accessories</p> <p>Specifications: Net Weight: 2.8 kg Lifting height: 382mm Range: 334mm</p>	<p>JB 21-00-15</p>	



Roll stand with gas assisted arm for height adjustment of monitor





FLAT SCREEN ARMS & ACCESSORIES

Extension arm and monitor bracket

	Description	P/N	RRP EUR
	<p>Extension arm in a stainless steel Can be mounted on the wall, table, ceiling, wall rails, equipment etc. The arm can potentially equalise Allen screws standard Available with adjustable handle</p> <p>Specifications: Net Weight: 1.1 kg Reach: 220mm</p>	<p>JB 22-00-00</p> <p>JB 94-00-00</p>	
	<p>Monitor Bracket Ø20mm, stainless steel (AISI 304) The bracket can potentially equalise</p> <p>Specifications: VESA: 75x75mm or 100x100mm Depth: 95mm Standard with the bolt. Available with adjustable handle</p>	<p>JB 27-00-00</p> <p>JB 46-00-00</p>	



Wall mount

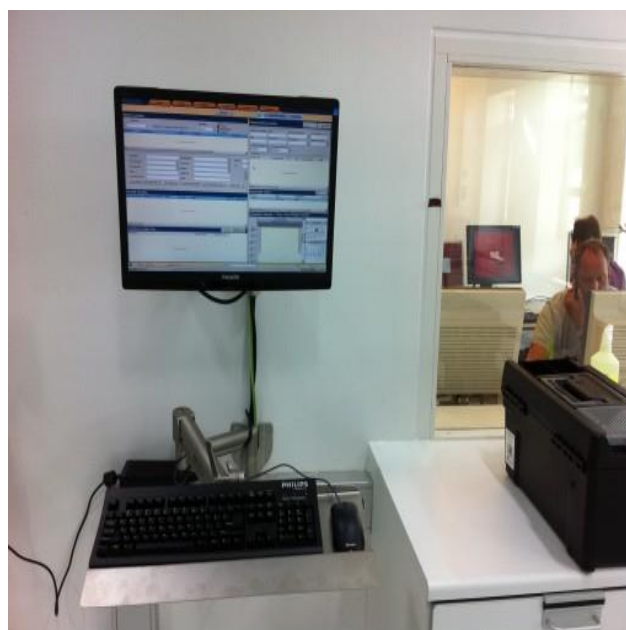

	<p>Description</p>	<p>P/N</p>	<p>RRP EUR</p>
	<p>Wall bracket, circular, 20mm Allen screws standard Available with adjustable handle Stainless steel (AISI 304)</p> <p>Specifications: H: 118.5mm D: 58mm</p>	<p>JB 31-00-00</p> <p>JB 94-00-00</p>	
	<p>Wall bracket extended Circular, 20mm This bracket was designed to make room for a screen if cable trays or shelves are close to the system</p> <p>Available with adjustable handle</p> <p>Specifications: H: 118.5mm D: 120mm</p>	<p>JB 241-00-00</p> <p>JB 94-00-00</p>	



Keyboard tray and suspensions for laptops

	Description	P/N	RRP EUR
	<p>Keyboard tray with hand support, 20mm Stainless steel (AISI 304) Tilting and reversible Available in different models Allen bolt standard Available with adjustable handle</p> <p>Specifications: L: 575mm W: 172mm</p>	<p>JB 43-01-00</p> <p>JB 46-00-00</p>	
	<p>A laptop suspension with Ø20mm shaft and extra wrist support</p> <p>Allen bolt standard Available with adjustable handle</p> <p>Specifications: Weight: Approx. 3.8 kg Customized measurements</p>	<p>JB 209-00-00</p> <p>JB 46-00-00</p>	
	<p>Tray with hand support made of stainless steel. Can be used for laptops and can be tilted and rotated</p> <p>Allen bolt standard Available with adjustable handle</p> <p>Specifications: W: 250mm L:370mm Weight: 2.2 kg Can be tilted: -25°/ +115°</p>	<p>JB 253-00-00</p> <p>JB 46-00-00</p>	

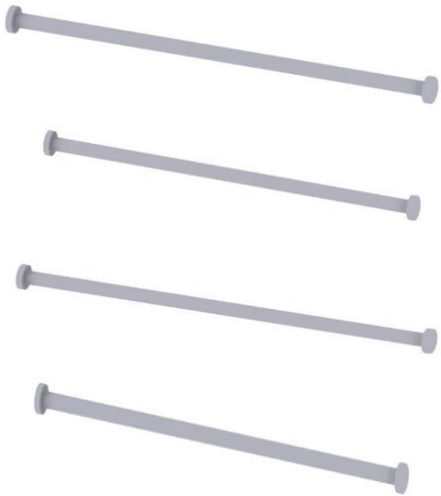
FLAT SCREEN ARMS & ACCESSORIES... continued

	Description	P/N	RRP EUR
	Rod, solid, Ø20 x 600mm with two end stops. SST (AISI 304)	JB 29-00-04	
	Rod, solid, Ø20 x 500mm with two end stops. SST (AISI 304)	JB 29-00-10	
	Rod, tube, Ø20 x 600mm with two end stops. SST (AISI 304)	JB 29-00-00	
	Rod, tube, Ø20 x 500mm with two end stops. SST (AISI 304)	JB 29-05-00	
	Bracket for attaching LCD Arm on an anaesthesia trolley We have different models for different Equipment makers, excl. Dräger and Dameca. Allen screws are standard	JB 49-00-00	
Available with adjustable handle	JB 94-00-00		



FLAT SCREEN ARMS & ACCESSORIES... continued



Desk clamp mounts

	Description	P/N	RRP EUR
	<p>Through-hole mount for 20mm shaft</p> <p>Mounting pole height: 95mm. Clamping distance: 0-41mm. Note: A 12mm (minimum) hole through desk is required. Made of stainless steel</p> <p>Allen screws standard Available with adjustable handle</p>	<p>JB 91-00-00</p> <p>JB 94-00-00</p>	
	<p>Standard clamp desk mount for 20mm shaft</p> <p>Mounting pole height: 95mm Clamping distance: 10-85mm Made of stainless steel Allen screws standard</p> <p>Available with adjustable handle</p>	<p>JB 90-00-00</p> <p>JB 94-00-00</p>	
 	<p>Adjustable handle M10 x 40mm</p> <p>Locking handle, e.g., Monitor Bracket & Keyboard tray</p> <p>Both made in Stainless steel</p> <p>Adjustable handle M6 x 20mm</p> <p>Locking handle, e.g. buckle clamping bracket and manual extension arm</p>	<p>JB 46-00-00</p> <p>JB 94-00-00</p>	

TABLET & IPAD- HOLDER/STAINLESS STEEL

	Description	P/N	RRP EUR
	<p>Tablet holder wall bracket Use of a tool can only remove the bracket. Thereby obtains security against impulse theft!</p> <p>There is an increasing demand for increased hygiene; therefore, made of glass-blown stainless steel that can withstand all detergents</p> <p>Suitable e.g. iPad Pro 9.7" iPad Air 2 9.7" Lenovo Tab 2 10"</p>	<p>JB 248-19-02</p>	
	<p>Tablet holder for bedside rails 10x25mm With slide clamp, the full model Locked using two socket screws</p> <p>Tablet holder for bedside rails 10x30mm With Slide clamp, wide model Locked using two socket screws</p> <p>Suitable e.g. iPad pro 9,7" iPad air2 9,7" Lenovo tab2 10"</p>	<p>JB 248-19-143 Fits only EU DIN rails (10x25mm)</p> <p>JB 248-19-206</p>	

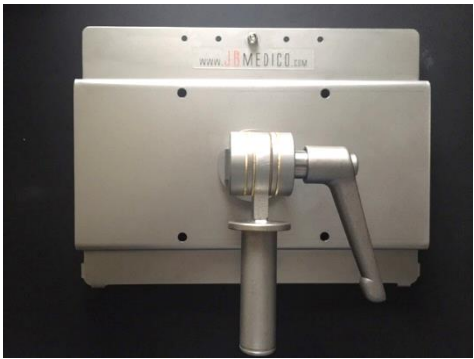
TABLET & IPAD-HOLDER/STAINLESS STEEL ... continued

	Description	P/N	RRP EUR
	<p>Tablet holder/Multibracket The holder can be mounted as follows: Beds + running equipment IV Stands & Columns Table Besides DIN Standard 10x25mm rails</p> <p>Suitable- e.g. iPad pro 9,7" iPad air2 9,7" Lenovo tab2 10"</p>	<p>JB 248-19-158</p>	
 	<p>Tablet Holder/Tilt Swivel The bracket fits our existing arm series and looks the same as a standard screen mount</p> <p>NOTE! The handle can be purchased but comes standard with bolt Lock: With a locking ring</p> <p>Suitable e.g. iPad pro 9,7" iPad air2 9,7" Lenovo tab2 10"</p> <p>Accessories: Wall bracket Ball clamp w/adapter bracket Various Arms</p>	<p>JB 248-19-27</p> <p>JB 46-00-00</p>	

TABLET & IPAD-HOLDER/STAINLESS STEEL GALLERY

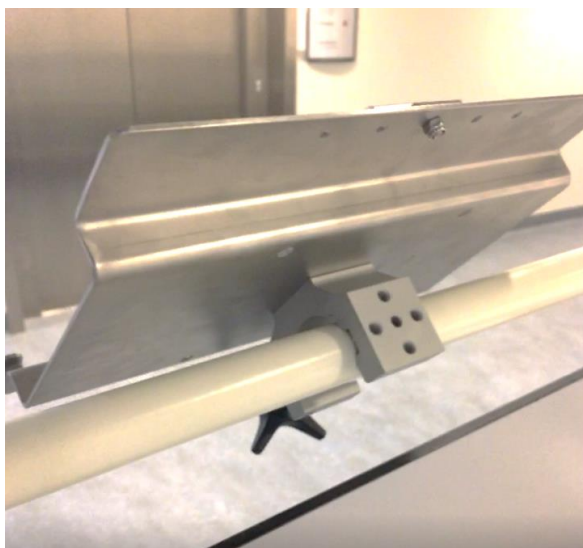
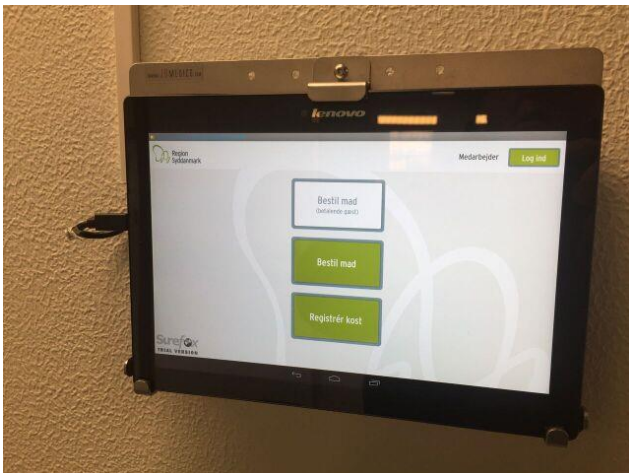

SOAP AND ALCOHOL STEEL DISPENSER FOR 1.0 L BAGS AND BOTTLE

Efficient and practically designed stainless steel dispenser for 1.0 l bags and bottle

The dispenser made for both soap, lotion and disinfection products

The optimum solution for a large number of segments including hospitals and nursing homes that need to comply with extraordinary hygiene requirements.

PRODUCT FACTS

Hygienic dispenser design with products kept in airtight bags for prevention of bacteria growth

Elbow-operated dispenser; reduces infection transmission

Easily mounted, operated, cleaned and refilled

Easily cleaned and the design prevents accumulation of unwanted dirt and bacteria growth

Environmental design as product package sizes reduces waste to a minimum







Soap and alcohol dispenser for bottles

	Description	P/N	RRP EUR
	<p>With 14 cm arm for a 1l bottle</p> <p>Specifications: Material: Thread electropolished stainless steel (AISI 304) Weight: pr. cl: 0,149 kg</p>	<p>JB 06-21-30</p> <p>MOQ 12 PCS.</p>	
	<p>With 10 cm arm for a 1l bottle</p> <p>Specifications: Material: Thread electropolished stainless steel (AISI 304) Weight: 0,142 kg</p>	<p>JB 06-21-40</p> <p>MOQ 12 PCS.</p>	
	<p>With 6 cm arm for a 1l bottle</p> <p>Specifications: Material: Thread electropolished stainless steel (AISI 304) Weight: 0,130 kg</p>	<p>JB 06-21-50</p> <p>MOQ 12 PCS.</p>	
	<p>Spacer, 85mm for all our wire dispenser</p> <p>The spacer makes it possible to mount a stainless dispenser further out from the wall</p>	<p>JB 728-87-67</p> <p>MOQ 10 PCS.</p>	



Soap and alcohol dispenser for bags

	Description	P/N	RRP EUR
	<p>With 14 cm arm for a 1l bag</p> <p>Specifications: Material: Thread electropolished stainless steel (AISI 304) Weight: 0,154 kg</p>	<p>JB 42-79-00</p> <p>MOQ 10 PCS.</p>	
	<p>With 10 cm arm for a 1l bag</p> <p>Specifications: Material: Thread electropolished stainless steel (AISI 304) Weight: 0,145 kg</p>	<p>JB 42-90-03</p> <p>MOQ 12 PCS.</p>	
	<p>With 6 cm arm for a 1l bags</p> <p>Specifications: Material: Thread electropolished stainless steel (AISI 304) Weight: 0,137 kg</p>	<p>JB 42-98-03</p> <p>MOQ 12 PCS</p>	
	<p>Adapter bracket for Soap & Alcohol dispensers and drip trays This bracket allowed to be picked up and cleaned without tools</p> <p>Specifications: Length: 92mm Height: 50mm Depth: 14mm Material: (AISI 304)</p>	<p>JB 213-00-00</p> <p>MOQ 10 PCS</p>	

Drip trays and Soap Dispenser

	Description	P/N	RRP EUR
	<p>Drip tray for Soap & Alcohol Automat dispenser</p> <p>Made in electro-polished stainless steel (AISI 304)</p> <p>For mounting directly on the wall</p>	<p>JB 116-00-00</p> <p>MOQ 10 PCS.</p>	
	<p>Drip tray that fits Soap & Alcohol wire dispensers</p> <p>In electro-polished stainless steel (AISI 304)</p> <p>For hanging on a wall rail or directly on the wall</p>	<p>JB 102-00-01</p> <p>MOQ 10 PCS.</p>	
	<p>Drip tray for Soap & Alcohol dispenser from "Sterisol."</p> <p>Made in electro-polished stainless steel (AISI 304)</p> <p>For hanging on a wall rail or the wall</p>	<p>JB 500-00-01</p> <p>MOQ 10 PCS.</p>	
	<p>Drip tray that fits Soap & Alcohol wire dispensers</p> <p>In electro-polished stainless steel (AISI 304)</p>	<p>JB 71-72-51</p> <p>MOQ 10 PCS.</p>	



Drip trays and Soap Dispenser continued

	Description	P/N	RRP EUR
	<p>Steel dispenser with a 6cm long arm for 1-litre bottles drip tray and adapter bracket</p> <p>Specifications: Electro-polished SS (AISI 304)</p> <p>Accessories: Multibracket with a T-slot T-Slot Wall bracket Slide clamp Scandinavian Standard Slide clamp DIN EU Standard</p>	<p>JB 50-213-102</p> <p>MOQ 4 PCS.</p> <p>JB 158-00-163 JB 47-00-00 JB 120-00-00 JB 146-00-00</p>	
	<p>Steel dispenser with a 10cm long arm for 1-litre bottles drip tray and adapter bracket</p> <p>Specifications: Electro-polished SS (AISI 304)</p> <p>Accessories: Multibracket with a T-slot T-Slot Wall bracket Slide clamp Scandinavian Standard Slide clamp DIN EU Standard</p>	<p>JB 40-213-102</p> <p>MOQ 4 PCS.</p> <p>JB 158-00-163 JB 47-00-00 JB 120-00-00 JB 146-00-00</p>	
	<p>Steel dispenser with a 14cm long arm for 1-litre bottles drip tray and adapter bracket</p> <p>Specifications: Electro-polished SS (AISI 304)</p> <p>Accessories: Multibracket with a T-slot T-Slot Wall bracket Slide clamp Scandinavian Standard Slide clamp DIN EU Standard</p>	<p>JB 30-213-102</p> <p>MOQ 4 PCS.</p> <p>JB 158-00-163 JB 47-00-00 JB 120-00-00 JB 146-00-00</p>	

Drip Tray Gallery



DISPENSER FOR OPERATIONS Masks & Facemask, T-slot BRIC

	Description	P/N	RRP EUR
 	<p>Dispenser for operating mask, Mouth band with T-trace piece</p> <p>The holder is made to fit all the hospital's own wall and backing fittings</p> <p>Specifications: (Internal dimensions) Stainless steel</p> <p>Width: 226mm Height: 110mm Depth: 188mm</p> <p>Accessories: T-Slot Wall bracket Slide clamp DK Standard Slide clamp DIN EU Standard</p>	<p>JB 185-110-135</p> <p>MOQ 2 PCS.</p> <p>JB 47-00-00 JB 120-00-00 JB 146-00-00</p>	

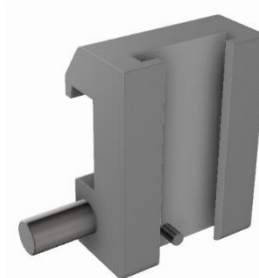
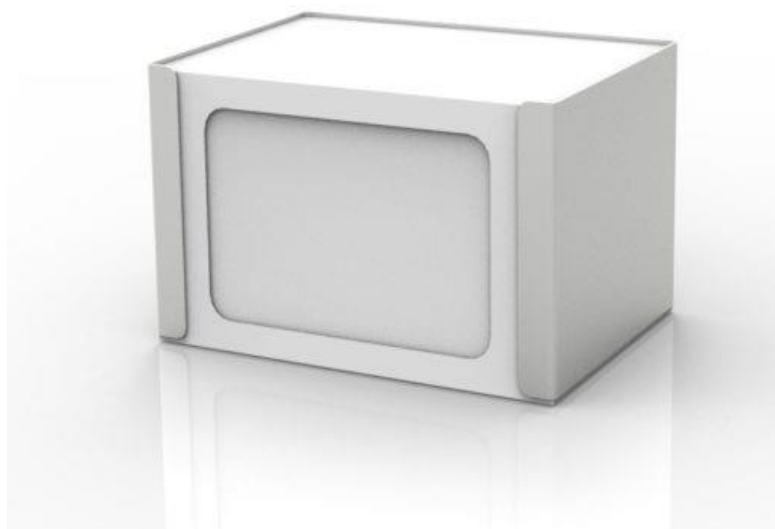

GLOVE BOX HOLDER & ACCESSORIES

P/N JB 800-00-00 Glove Box "HandsUp"

RRP EUR / MOQ 4 PCS.

With "HandsUp", staff can finally see the sizes of gloves, which always printed on the sides of the boxes.

Fits 99% of all glove boxes

Suitable for Wet Wipes (the big ones)

Ideal for muzzle & mask boxes

"HandsUp" is installed in both horizontal and vertical positions.

Mounted on wall brackets, with T-track or wall rail. Resists autoclaving

Specifications:

H: 240mm W: 150mm D: 108mm Weight: 0.3 kg Material: 4mm Stainless Steel AISI 304

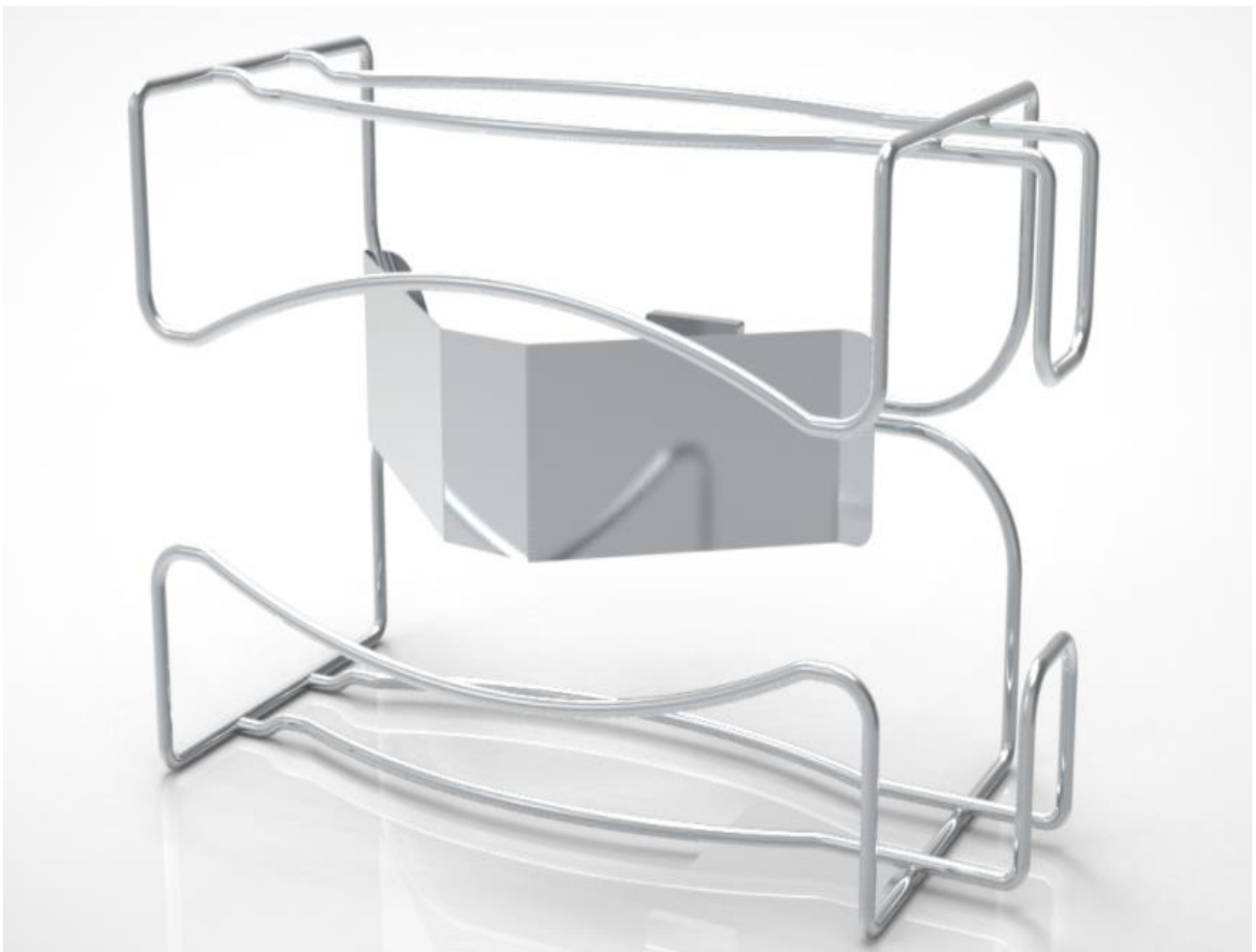

Gallery off HandsUp



Glove Box Holder & Accessories

	Description	P/N	RRP EUR
	<p>T-slot bracket for multi-bracket (JB 158-00-00) holes only fit there!</p> <p>Specifications: H: 60mm, W: 36,2mm D: 12,5mm Anodised aluminum C-profile Hole size: Ø6,4mm</p>	<p>JB 163-00-01</p> <p>MOQ 10 PCS.</p>	
	<p>T-Slot Wall bracket for one glove box holders, wastebaskets, drip trays, needle boxes, suction catheter & container</p> <p>Specifications: H: 60mm, W: 36,2mm D: 12,5mm Anodised aluminum C-profile Hole size: Ø4,3mm</p>	<p>JB 47-00-00</p> <p>MOQ 10 PCS.</p>	
	<p>T-Slot bracket for two glove box holders</p> <p>C profile with four countersunk mounting holes and a stop screw</p> <p>Specifications: H: 210mm W: 36,2mm D: 2,5mm Hole size: Ø6,4mm Weight: 0,1 kg Anodised aluminium C-profil</p>	<p>JB 47-00-02</p> <p>MOQ 5 PCS.</p>	

Glove Box Holder & Accessories continued

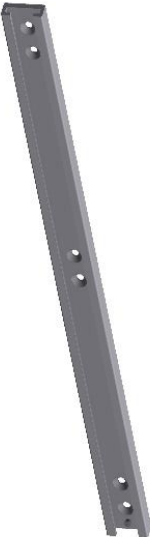
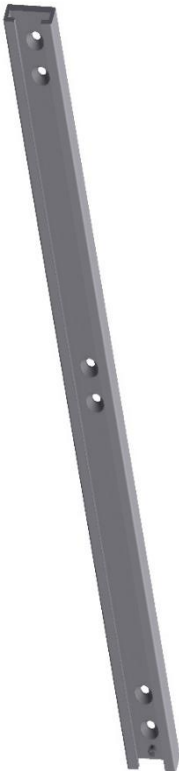
	Description	P/N	RRP EUR
	<p>T-Slot bracket for three glove box holders</p> <p>C-profile with four countersunk mounting holes and a stop screw</p> <p>Specifications: Length: 360mm Hole size: Ø6,4mm Weight: 0,2 kg Anodised aluminum C-profile</p>	<p>JB 47-00-03</p> <p>MOQ 5 PCS.</p>	
	<p>T-Slot bracket for four glove box holders</p> <p>C-profile with four countersunk mounting holes and a stop screw</p> <p>Specifications: Length: 520mm Hole size: Ø6,4mm Weight: 0.3 kg Anodised Aluminium C-profile</p>	<p>JB 47-00-04</p> <p>MOQ 5 PCS.</p>	

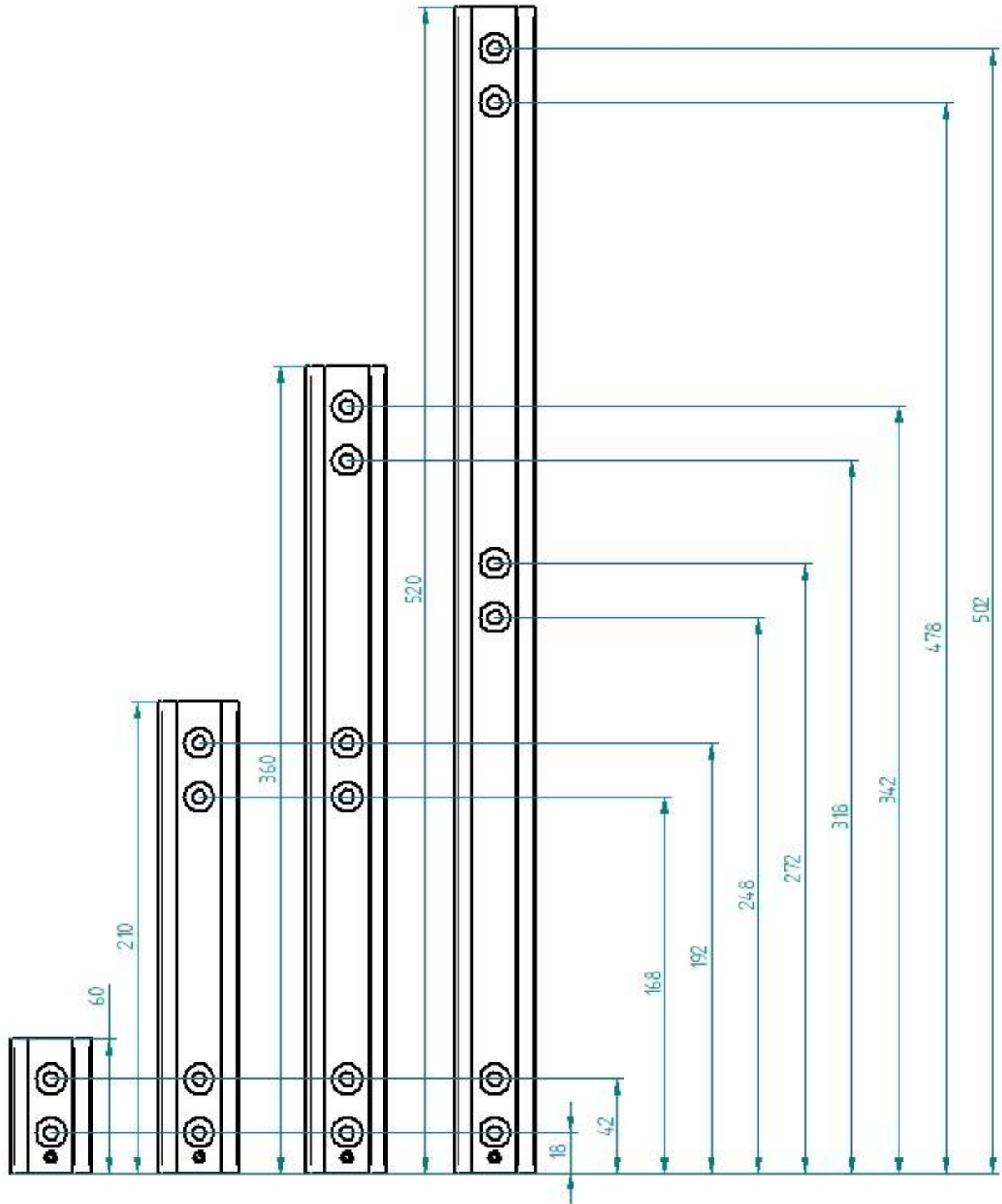



Triple Glove Dispenser

P/N: JB 110-00-00

RRP EUR: / MOQ 4 PCS.

Specifications: H: 406mm/D: 93mm (Internal Dimensions)/W: 283 (Internal Dimensions)

Material: Stainless steel AISI 30

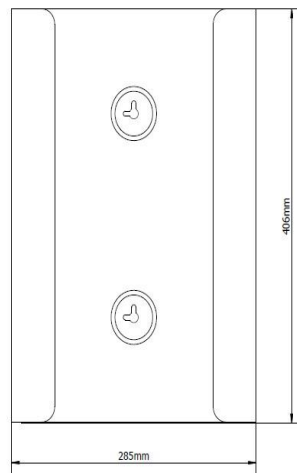

IV STANDS & IV POLES “ONE HAND”

IV Pole “Small” with One Hand telescopic solution

P/N: JB 306-2-317-211

RRP EUR





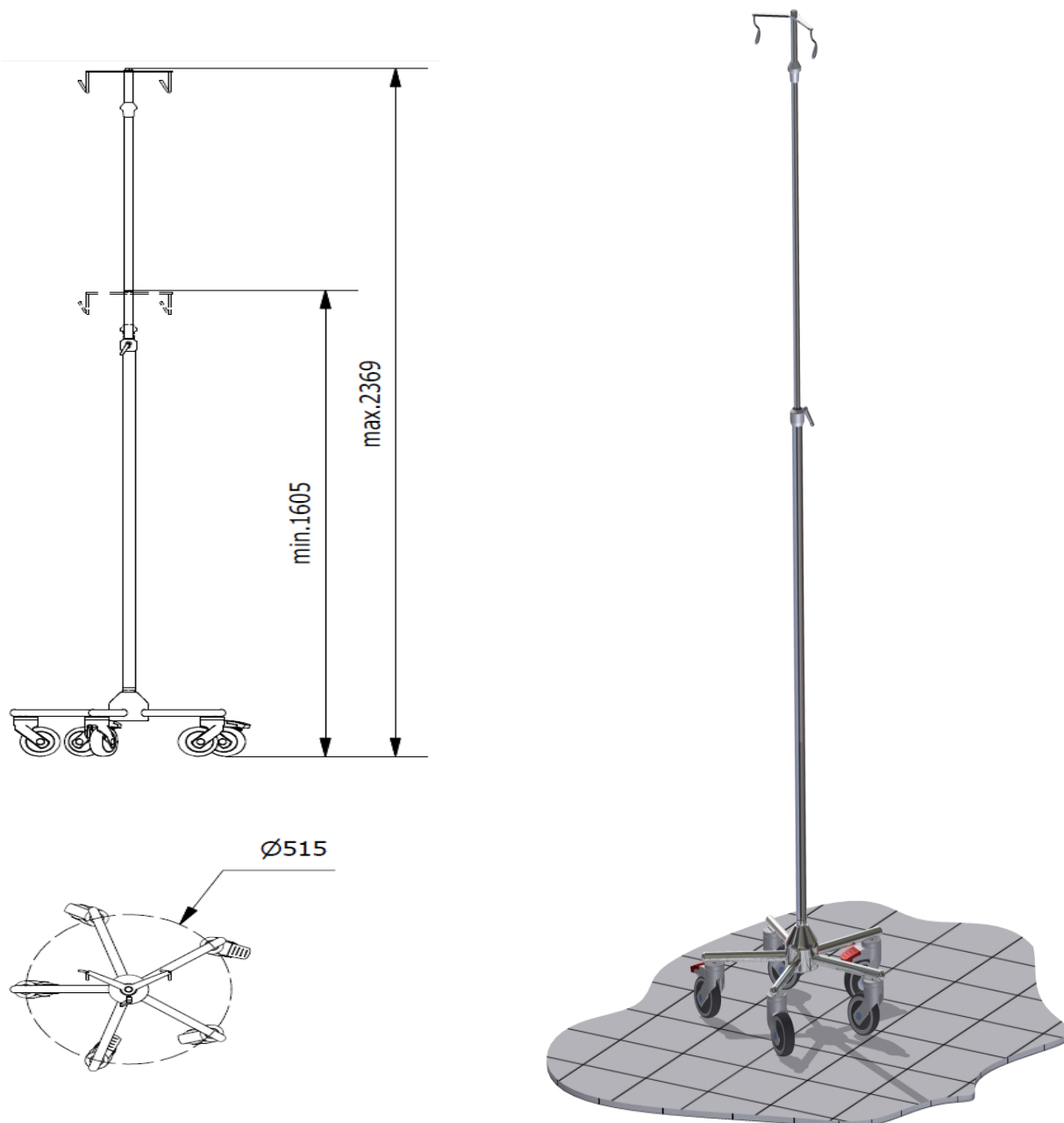

This IV Pole manufactured in stainless steel and provided effective infusion care by ensuring safe suspension of IV bottles and bags on the pole.

Mobile use: At the right time in the right place

Modify the adjustable IV pole as needed.



Specifications

P/N	JB 306-2-317-211
Material	Electropolished stainless steel AISI 304
Colour of plastic parts	Black
Hooks Load per hook No risk of injury from the rounded shape of the hooks	Stainless steel with two strong angled hooks 5 kg
Weight without equipment	15 kg
Max load	40 kg
Height with/without wheels (telescope max) Height with/without wheels (telescope mine)	2.370mm/2.232mm 1.605mm/ 1.470mm
Outer tube diameter and length	Ø32/1.259mm
Inner tube diameter and length	Ø20 x 940mm
Adjustment	"One Hand" adjustable
Height adjustment	765mm
Base diameter, straight leg	515mm
Castors According to DIN EN 60601 electrically conductive and lockable	Ø100mm single wheel (2 x antistatic Stainless, lockable, and 3-x standard)
Enough safe distance in between both tubes once the pole reached its lowest height	An integrated base-weights facilitates a more reliable attachment of various pumps and other medical equipment
Integrated pull-out guard avoids separation of the adjustable tubes	   www.jbmedico.com
<p><u>For your understanding</u></p> <div style="display: flex; justify-content: space-around; align-items: center;"> <div data-bbox="217 1783 408 1899">  </div> <div data-bbox="528 1783 778 1906">  </div> <div data-bbox="903 1783 1153 1906">  </div> <div data-bbox="1262 1783 1453 1899">  </div> </div>	

IV Pole “XXL” with One Hand telescopic solution

One Hand with curved legs, big wheels, long curved column, six strong hooks

P/N.: JB 332-2-321-216

RRP EUR

Mobile use: At the right time in the right place

Modify the adjustable IV pole as needed



The massive specially designed stainless steel frame enables the attachment of div. topics in a safe way, without having to be afraid to stand overturns

Space-saving storage thanks to an intelligent base and pole construction

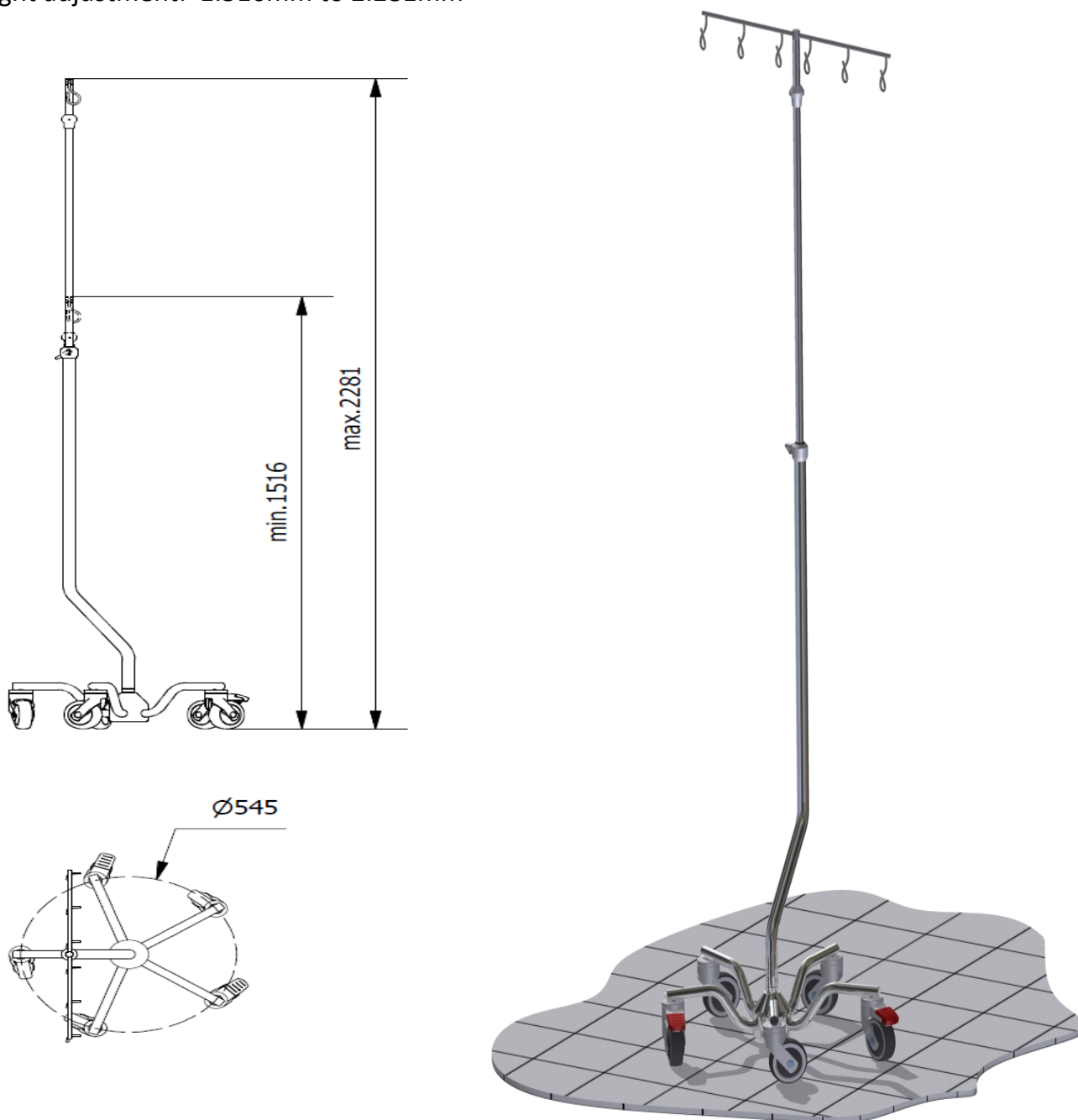
Height adjustment: 1.516mm to 2.281mm



Specifications

P/N	JB 332-2-321-216
Material	Electropolished Stainless steel AISI 304
Colour of plastic parts	Black
Hooks Load per hook	SST with six strong straight hooks 15 kg
Weight without equipment	15 kg
Max load	50 kg
Height with/without wheels (telescope max) Height with/without wheels (telescope mine)	2.281mm/ 2.144mm 1.516mm/ 1.379mm
Outer tube diameter and length	Ø32/ 1.281mm
Inner tube diameter and length	Ø20 x 940mm
Adjusting	"One Hand" adjustable
Height adjustment	765mm
Base diameter, leg	545mm
Castors According to DIN EN 60601 electrically conductive and lockable	Ø100mm mono castors 1 x Antistatic, 2 x Lockable & 2 x Standard SST
Enough safe distance in between both tubes once the pole reached its lowest height	An integrated base-weights facilitates a more reliable attachment of various pumps and other medical equipment
Integrated pull-out guard avoids separation of the adjustable tubes	   www.jbmedico.com

For your understanding



IV Pole "XLL" with One Hand telescopic solution

One Hand with curved legs, big wheels, long curved column, four strong hooks

P/N.: JB 332-2-320-190

RRP EUR:

Height adjustment: 1.516mm to 2.281mm

Mobile use: At the right time in the right place



Modify the adjustable IV pole as needed.

The massive specially designed stainless steel frame enables the attachment of div. topics in a safe way, without having to be afraid to stand to overturn

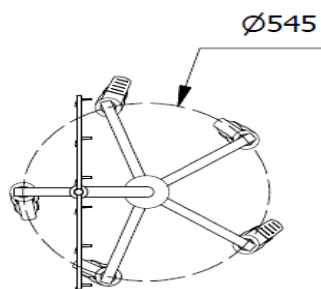
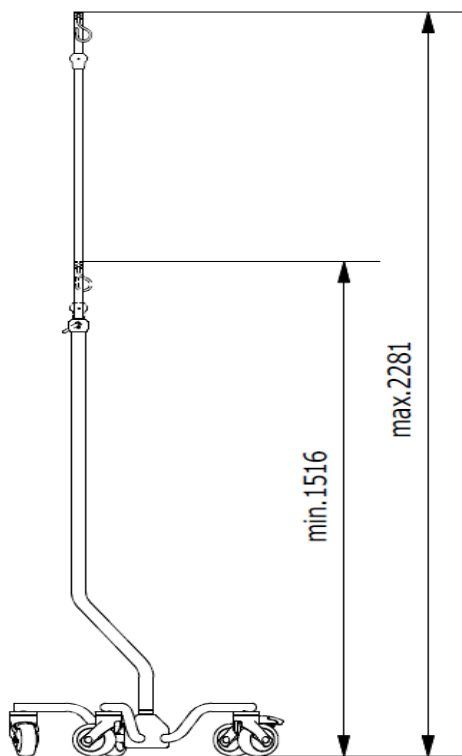
Space-saving storage thanks to an intelligent base and pole construction



Specifications

P/N	JB 332-2-320-190
Material	Electropolished Stainless steel AISI 304
Colour of plastic parts	Black
Hooks Load per hook	SST with four strong straight hooks 15 kg
Weight without equipment	15 kg
Max load	50 kg
Height with/without wheels (telescope max) Height with/without wheels (telescope mine)	2.281mm/ 2.144mm 1.516mm/ 1.379mm
Outer tube diameter and length	Ø32
Inner tube diameter and length	Ø20 x 940mm
Adjusting	"One Hand" adjustable
Height adjustment	765mm
Base diameter, straight leg	545mm
Castors According to DIN EN 60601 electrically conductive and lockable	Ø100mm mono castors 1 x Antistatic, 2x Lockable & 2 x Standard SST
Enough safe distance in between both tubes once the pole reached its lowest height	An integrated base-weights facilitates a more reliable attachment of various pumps and other medical equipment
Integrated pull-out guard avoids separation of the adjustable tubes	   www.jbmedico.com

For your understanding



Security

- Outer an inner poles provided with plastic stoppage (no risk of damage)
- Adequate safety clearance in the collapsed mode as a precautionary measure against safety (e.g. squeezing fingers)
- Increased stability due to the conical connection between the stand and foot section
- No risk of damage due to rounded bottleneck shape
- Due to the geometry of hooks, the infusion bottles can't fall out

Technique

- All plastic parts are lightweight
- Stainless steel pipes according to DIN EN 10217-7
- Material ultrasound and vortex tested (according to EN 10246-9/3)
- The integrated pull-out limiter prevents the adjustable pipes from being separated
- Safety bottle crossing according to DIN ISO 15375
- Good driving qualities through high-quality 100mm mono rolls, two rolls are antistatic
- The introduction of hygienically sensitive fluids prevented by sealing cover
- Enhanced bottle holder allows for the connection of 5-litre bottle
- Enough safe distance in between both tubes once the pole reached its lowest height
- An integrated base-weights facilitates a more reliable attachment of various pumps and other medical equipment
- Integrated pull-out guard avoids separation of the adjustable tubes

For your understanding



IV Pole

JBMEDICO
www.jbmedico.com

IV- Stands/IV-Poles

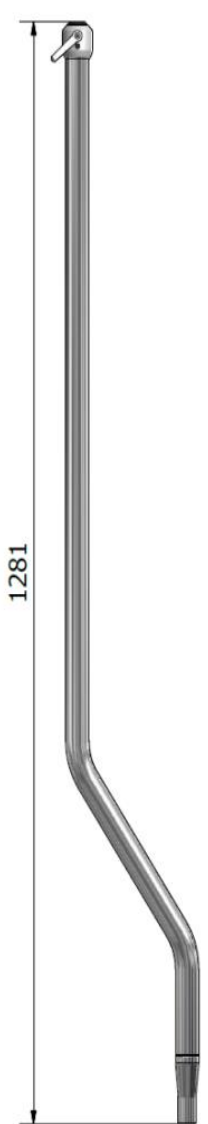
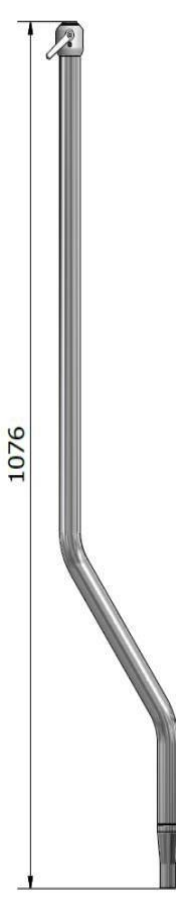
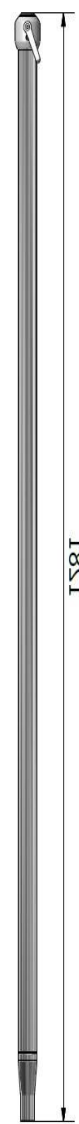
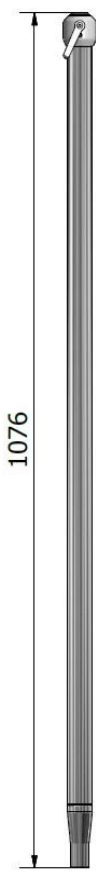
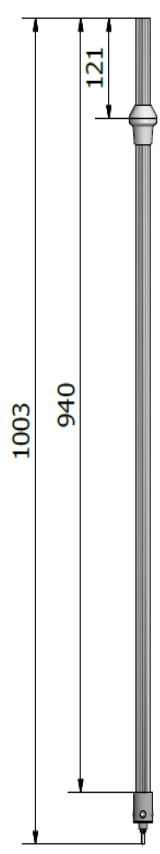

P/N JB 320-00-02	P/N JB 321-00-02	P/N JB 317-00-05	P/N JB 319-00-03	P/N JB 317-00-13
Spec.	Spec.	Spec.	Spec.	Spec.
Bended, long outer tube	Bended, short outer tube	Straight outer tube, long	Straight outer tube, short	Telescopic pole fits IV – Stands
L: 1281mm D: Ø32mm	L: 1076mm D: Ø32mm	L: 1281mm D: Ø32mm	L: 1076mm D: Ø32mm	L: 940mm D: Ø20mm
SST AISI 304	SST AISI 304	SST AISI 304	SST AISI 304	SST AISI 304
				

Bottle holders for IV pole

	Description	P/N	RRP EUR
	<p>Bottle holder, double for IV Pole, straight</p> <p>Electro-polished SST AISI 304</p> <p>Specifications: Weight: 0.3 kg</p>	<p>JB 204-00-00</p>	
	<p>Bottle holder, double for IV Pole</p> <p>Electro-polished SST AISI 304</p> <p>Specifications: Weight: 0.3 kg</p>	<p>JB 211-00-00</p>	
	<p>Bottle holder, triple for IV Pole</p> <p>Electro-polished SST AISI 304</p> <p>Specifications: Weight: 0-4 kg</p>	<p>JB 212-00-00</p>	
	<p>Bottle holder, quadruple for IV Pole</p> <p>Electro-polished SST AISI 304</p> <p>Specifications: Weight: 0.5 kg</p>	<p>JB 190-00-08</p>	
	<p>Bottle holder, 6 hooks for IV Pole</p> <p>Electro-polished SST AISI 304</p> <p>Specifications: Weight: 0.6 kg</p>	<p>JB 216-00-00</p>	

IV poles accessories

Pushing handle for IV stand/ IV pole

	Description	P/N	RRP EUR
	<p>Pushing handle Material: stainless steel The pushing handle can adjust from 16mm to Ø41mm</p> <p>Specifications: Weight without multibracket: 0.4kg Weight with multibracket: 0.5kg Length: 200mm Width: 190mm Diameter: 20mm</p>	<p>JB 294-00-05</p> 	
	<p>Telescopic pole fits clamps</p> <p>Specifications: L: 940mm D: Ø20mm Electro-polished SST AISI 304</p>	<p>JB 190-00-05</p>	

IV poles accessories... continued

	Description	P/N	RRP EUR
   	<p>4-Position Transducer Mount made in aluminium. Easy to clean and fits most transducers.</p> <p>Accessories: Multibracket with a T-slot</p>	<p>JB 289-00-00</p> <p>MOQ 4 PCS.</p> <p>JB 158-00-163</p>	
	<p>IV Hook stainless steel for infusion bags and IV fluids</p> <p>Dimensions: Ø8x200mm. Made of SST, with an end-bow.</p> <p>The rod fits all our existing fittings with the control for T-tracks</p> <p>Material: Electropolished 8-mm stainless steel rod, AISI 304</p> <p>Space for 5-6 drip bags</p>	<p>JB 205-08-05</p> <p>MOQ 4 PCS.</p>	

OXYGEN & GAS CYLINDER HOLDERS

Wall mount, CO2 bottles, Ø175mm



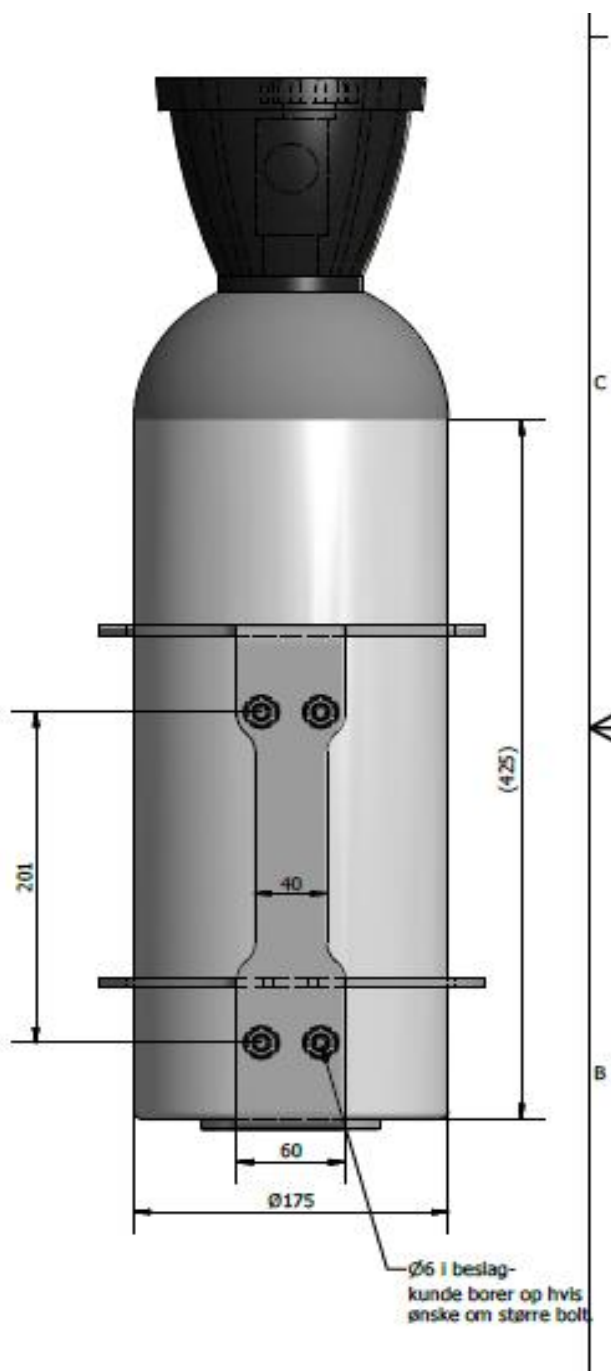

Wall fittings for CO2 bottles fit, e.g. Air Liquide 6 litre bottle holder for wall, for Ø175mm bottles
P/N. JB 283-01-00

RRP EUR

Electropolished stainless Steel: AISI 304





Oxygen & Gas cylinder holders

	Description	P/N	RRP EUR
 <p data-bbox="172 689 443 719">Pic. With Multibracket</p>	<p data-bbox="528 383 1007 456">Oxygen & Gas cylinder holder top For Ø117mm cylinders</p> <p data-bbox="528 506 970 624">Material: 8mm Electropolished stainless steel rod Weight: 0,2kg</p> <p data-bbox="528 674 876 703">Multibracket with T-Slot</p>	<p data-bbox="1134 383 1323 412">JB 290-01-00</p> <p data-bbox="1142 506 1315 535">MOQ 2 PCS.</p> <p data-bbox="1126 674 1331 703">JB 158-00-163</p>	
 <p data-bbox="172 1108 443 1137">Pic. With Multibracket</p>	<p data-bbox="528 757 1070 875">Oxygen & Gas cylinder holder, bottom for Ø117mm cylinders with flat bottoms</p> <p data-bbox="528 925 970 1043">Material: 8mm Electropolished stainless steel rod Weight: 0,3kg</p> <p data-bbox="528 1093 876 1122">Multibracket with T-Slot</p>	<p data-bbox="1134 757 1323 786">JB 290-02-00</p> <p data-bbox="1142 925 1315 954">MOQ 2 PCS.</p> <p data-bbox="1126 1093 1331 1122">JB 158-00-163</p>	
 <p data-bbox="172 1507 443 1536">Pic. With Multibracket</p>	<p data-bbox="528 1193 1007 1267">Oxygen & Gas cylinder holder top For Ø140mm cylinders</p> <p data-bbox="528 1317 970 1435">Material: 8mm Electropolished stainless steel rod Weight: 0,2kg</p> <p data-bbox="528 1485 876 1514">Multibracket with T-Slot</p>	<p data-bbox="1134 1193 1323 1223">JB 277-01-00</p> <p data-bbox="1142 1317 1315 1346">MOQ 2 PCS.</p> <p data-bbox="1126 1485 1331 1514">JB 158-00-163</p>	
 <p data-bbox="172 1937 443 1966">Pic. With Multibracket</p>	<p data-bbox="528 1588 1067 1706">Oxygen & Gas cylinder holder bottom For Ø140mm cylinders with flat bottoms</p> <p data-bbox="528 1756 970 1874">Material: 8mm Electropolished stainless steel rod Weight: 0,3kg</p> <p data-bbox="528 1924 876 1953">Multibracket with T-Slot</p>	<p data-bbox="1134 1588 1323 1617">JB 277-02-00</p> <p data-bbox="1142 1756 1315 1785">MOQ 2 PCS.</p> <p data-bbox="1126 1924 1331 1953">JB 158-00-163</p>	

Bottle holders Gallery



BRACKET FOR SHARPS CONTAINERS, ELECTROPOLISHED STAINLESS STEEL





	Description	P/N	RRP EUR
	<p>Sharps 0.7 & 1.5 litre AP Medical DISPO Line</p> <p>Yellow or red lid</p>		
	<p>Bracket for e.g. AP Medical 0,7 & 1,5 Litre sharps containers</p> <p>Specifications: Inner diameter: Ø100mm Weight: 0.2 kg Material: Electropolished 8mm stainless steel rod, AISI 304</p>	<p>JB 255-00-00</p> <p>MOQ 5 PCS.</p>	



Bracket for a sharps container

	Description	P/N	RRP EUR
	<p>Sharps 2 litre AP Medical DISPO Line</p> <p>Yellow or red lid</p>		
	<p>Bracket e.g. 1.3-1.5 +2 +3.</p> <p>1 litre round sharps containers</p> <p>Specifications: Inner diameter: \varnothing134mm Weight: 0.2 kg Material: Electropolished 8mm stainless steel rod, AISI 304</p>	<p>JB 149-00-00</p> <p>MOQ 5 PCS.</p>	

Bracket for a sharps container

	Description	P/N	RRP EUR
	<p>Sharp Container 2 litre AP Medical CS line</p> <p>Yellow or red lid</p>		
	<p>Sharp Container 4 litre AP Medical CS line</p> <p>Yellow or red lid</p>		
	<p>Sharp Container 7 litre AP Medical CS Plus line</p> <p>Yellow or red lid</p>		
	<p>Bracket, e.g. AP Medical 2-4-& 7 litre sharps containers</p> <p>Specifications: Inner diameter: 133 x 133mm Weight: 0.3 kg Material: Electropolished 8mm stainless steel rod, AISI 304</p>	<p>JB 159-00-00</p> <p>MOQ 5 PCS.</p>	

Bracket for a sharps container

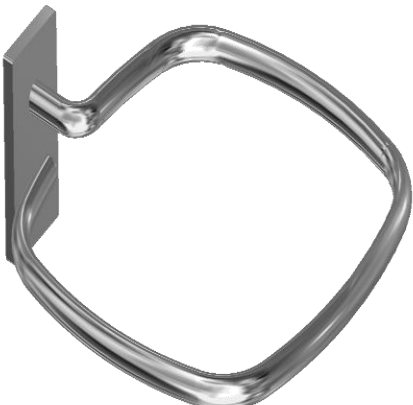

	Description	P/N	RRP EUR
	<p>Sharp Container 3 litre AP Medical CS line</p> <p>Yellow or red lid</p>		
	<p>Bracket, e.g. AP Medical 3 litre oval sharps containers</p> <p>Specifications: Inner diameter: 142x 143mm Weight: 0.3 kg Material: Electropolished 8mm stainless steel rod, AISI 304</p>	<p>JB 169-00-00</p> <p>MOQ 5 PCS.</p>	

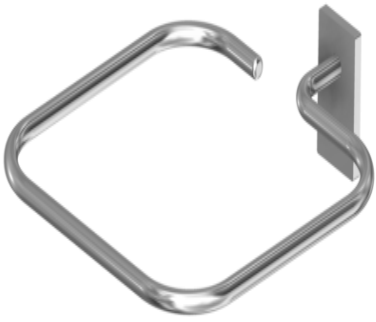
Bracket for a sharps container

	Description	P/N	RRP EUR
	<p>Sharp Container 4 or 7-litre "Sharpsafe" box</p> <p>Yellow or red lid</p>		
	<p>Bracket, e.g. 4 litre & 7-litre Sharpsafe Containers</p> <p>Specifications: Inner dimensions: 156 x 156mm Weight: 0.3 kg Material: Electropolished 8mm stainless steel rod, AISI 304</p>	<p>JB 154-00-00</p> <p>MOQ 5 PCS.</p>	





Bracket for a sharps container

	Description	P/N	RRP EUR
	<p>Sharp Container "Sharpsafe Quiver" 7,5 Litre</p> <p>Yellow or red lid</p>		
	<p>Bracket, e.g. 7,5-litre sharps containers</p> <p>Specifications: Inner dimensions: 101x147mm Weight: 0.4 kg Material: Electropolished 8mm stainless steel rod, AISI 304</p>	<p>JB 279-00-00</p> <p>MOQ 5 PCS.</p>	



Bracket for sharps container” Europlásticos.”

	Description	P/N	RRP EUR
	<p>Sharp Container 1 litre Europlásticos</p> <p>Yellow or red lid</p>		
	<p>Bracket, e.g. 1 litre sharp containers from Europlásticos</p> <p>Specifications: Inner dimensions: 96 x 96mm Weight: 0.2 kg Material: Electropolished 8mm stainless steel rod, AISI 304</p>	<p>JB 170-00-00</p> <p>MOQ 5 PCS.</p>	



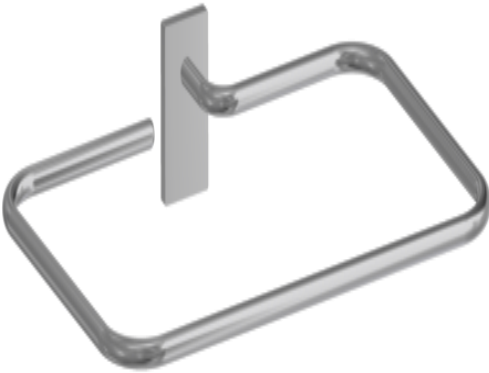

Bracket for a sharps container
Bracket Square

	Description	P/N	RRP EUR
	<p>Bracket, e.g. 4- 6 & 11- litre "Safebox" sharps containers</p> <p>Specifications: Inner dimensions: 252 x 157mm Weight: 0.4 kg Material: Electropolished 8mm stainless steel rod, AISI 304</p>	<p>JB 166-00-00</p> <p>MOQ 5 PCS.</p>	





Bracket for sharps container round

	Description	P/N	RRP EUR
	<p>Bracket, e.g. 0,6 Litre Sharpsafe Containers</p> <p>Specifications: Inner diameter: \varnothing89mm Weight: 0.3 kg Material: Electropolished 8mm stainless steel rod, AISI 304</p>	<p>JB 151-00-00</p> <p>MOQ 5 PCS.</p>	
	<p>Bracket for sharps containers, suitable, e.g. Dispo Line 0,5- & 1 Litre boxes</p> <p>Specifications: Inner diameter: \varnothing73mm Weight: 0.2 kg Material: Electropolished 8mm stainless steel rod, AISI 304</p>	<p>JB 150-00-00</p> <p>MOQ 5 PCS.</p>	
	<p>Bracket for sharps containers, suitable, e.g. Mediq 5 & 7 Litre round boxes</p> <p>Specifikationer: Inner diameter: \varnothing200mm Weight: 0,3 kg Material: Electropolished 8-mm stainless steel rod, AISI 304</p>	<p>JB 264-00-00</p> <p>MOQ 5 PCS.</p>	





Bracket for sharps container round... continues



	Description	P/N	RRP EUR
	<p>Bracket for sharps containers fit, e.g. USON, 21 & 21 litre Mediq "Jokey" boxes</p> <p>Specifications: Inner diameter: Ø280mm Weight: 0.4 kg Material: Electropolished 8mm stainless steel rod, AISI 304</p>	<p>JB 267-00-00</p> <p>MOQ 5 PCS.</p>	
	<p>Bracket for sharps containers fit, e.g. USON, 11 & 11 litre Mediq "Jokey" boxes</p> <p>Specifikationer: Inner diameter: Ø251mm Weight: 0,4 kg Material: Electropolished 8mm stainless steel rod, AISI 304</p>	<p>JB 266-00-00</p> <p>MOQ 5 PCS.</p>	

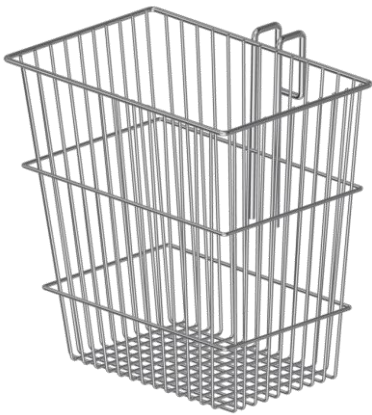

WIRE BASKETS & WIRE PRODUCTS ELECTROPOLISHED STAINLESS STEEL

	Description	P/N	RRP EUR
	<p>Wire basket 6 litres, conical with a hook for T-slot bracket</p> <p>Specifications: Width: 231mm Depth: 161mm Height: 242mm Weight: 0.8 kg Volume: 6 l</p>	<p>JB 161-00-00</p> <p>MOQ 5 PCS.</p>	
	<p>Wire basket 7 litres, conical with a hook for T-slot bracket</p> <p>Specifications: Width: 326mm Depth: 217mm Height: 132mm Weight: 0.7 kg Volume: 7 l</p>	<p>JB 161-01-01</p> <p>MOQ 5 PCS.</p>	
	<p>Wire basket 15 litres, conical with a hook for T-slot bracket</p> <p>Specifications: Width: 337mm Depth: 233mm Height: 267mm Weight: 1 kg Volume: 15 l</p>	<p>JB 161-02-01</p> <p>MOQ 5 PCS.</p>	

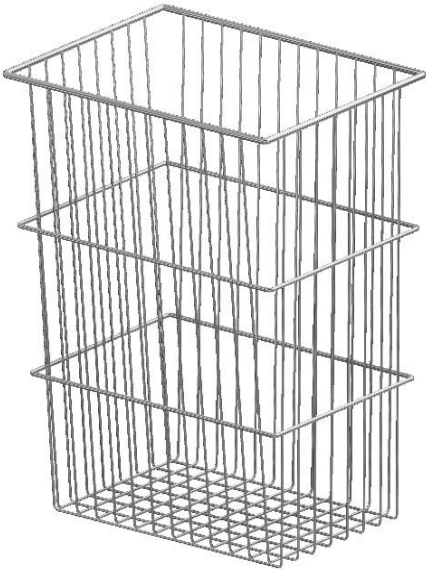
Wire Baskets & Wire Products continued

	Description	P/N	RRP EUR
	<p>Wire basket 25 litre conical, made of SST</p> <p>Specifications: Width: 350mm Depth: 250mm Height: 400mm Weight: 1.3 kg Volume: 25 L</p> <p>Two wall brackets for each basket Electropolished SST</p>	<p>JB 161-03-00</p> <p>MOQ 5 PCS.</p> <p>JB 281-00-00</p> <p>MOQ 10 pcs</p>	
	<p>Mask & tubing hook for T-slot brackets</p> <p>Electropolished stainless steel</p> <p>Specifications: Weight: 0.8 kg Depth: 76mm</p>	<p>JB 162-00-00</p> <p>MOQ 10 pcs</p>	

Beakers and Catheter containers

	Description	P/N	RRP EUR
	<p>Beaker 0.5 litre with an integrated holder for T-slot brackets</p> <p>Specifications: Weight: 0.3 kg Volume: 0.5 litre Material: Electropolished stainless steel, AISI 304</p>	<p>JB 236-00-00</p> <p>MOQ 4 PCS.</p>	
	<p>Beaker 1.0 litre with an integrated holder for T-slot brackets</p> <p>Specifications: Weight: 0.5 kg Volume: 1 litre Material: Electropolished stainless steel, AISI 304</p>	<p>JB 237-00-00</p> <p>MOQ 4 PCS.</p>	
	<p>Beaker 2.0 litre with an integrated holder for T-slot brackets</p> <p>Specifications: Weight: 0.7 kg Volume: 2 litre Material: Electropolished stainless steel, AISI 304</p>	<p>JB 238-00-00</p> <p>MOQ 4 PCS.</p>	

Beakers and Catheter containers





	Description	P/N	RRP EUR
	<p>Bracket Ø100mm for suction glass from Abbott/Hospira 2.000ml</p> <p>Specifications: Weight: 0.2 kg Material: Electropolished 8mm stainless steel rod, AISI 304</p>	<p>JB 100-00-00</p> <p>MOQ 5 PCS.</p>	
	<p>Catheter container, height 400mm. with an integrated holder for a T-slot</p> <p>Specifications: Weight: 0.9 kg Volume: 2 litre Height: 400mm Material: Electropolished stainless steel, AISI 304</p>	<p>JB 239-00-00</p> <p>MOQ 5 PCS.</p>	
	<p>Bracket with integrated T-slot holder for "Catheter Containers made in plastic."</p> <p>Specifications: Inner diameter: Ø66mm Weight: 0.1 kg Material: Electropolished 8mm stainless steel rod, AISI 304</p>	<p>JB 167-00-00</p> <p>MOQ 5 PCS.</p>	

Toilet Brush Holder

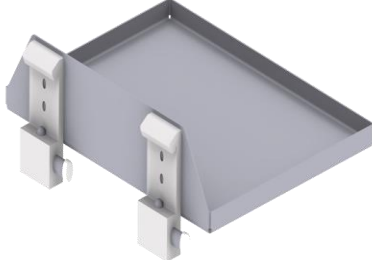

	Description	P/N	RRP EUR
	<p>Toilet brush holder for most round and oval brushes in plastic</p> <p>The holder made of aluminium</p> <p>Anodised in natural colour</p> <p>Specifications:</p> <p>Thickness: 5mm Depth: 140mm Height: 150mm Diameter: Ø 90mm</p> <p>Accessories:</p> <p>Can be ordered with: Wall bracket or Wall mount with socket screw for locking</p>	<p>JB 350-00-00</p>	
		<p>JB 47-00-00</p> <p>JB 47-01-01</p>	



Various accessories

	Description	P/N	RRP EUR
	<p>Pull-cord 2.5m for PATIENT CALL AND CALL SYSTEMS Pull-cord 2.5 meter manufactured in antibacterial plastic At the pull-cord, there is one ball, divided into two halves by too hard pull The ball can later assemble in almost all wall cans with the help of staff</p>	<p>JB IP 9025</p> <p>MOQ 25 PCS. In a bag</p>	
	<p>Record folder tray Stainless steel (AISI 304)</p> <p>Mounting on medical equipment rails with sliding clamps Specification: E.G. D:20 cm x W: 30 cm</p>	<p>JB 98-00-00</p>	
	<p>Cable clips for Ø20mm, pipe thickness</p> <p>Made of stainless spring steel</p>	<p>JB 56-00-00</p> <p>MOQ 10 PCS.</p>	
	<p>Cable clips for Ø30mm pipe thickness</p> <p>Made of stainless spring steel</p>	<p>703</p> <p>MOQ 10 PCS</p>	
	<p>Cable clips for Ø50mm pipe thickness</p> <p>Made of stainless spring Steel</p>	<p>705</p> <p>MOQ 10 PCS</p>	

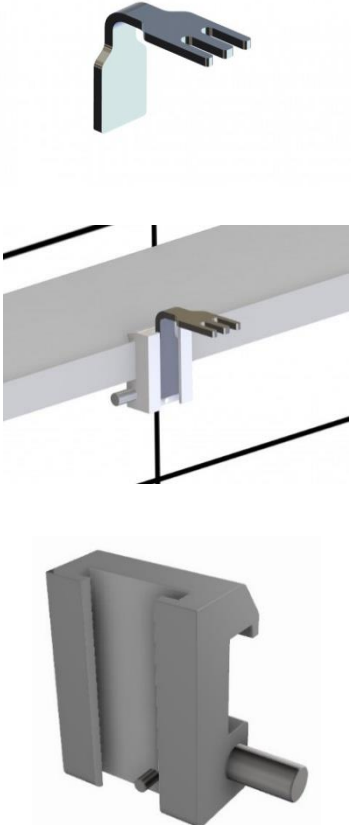
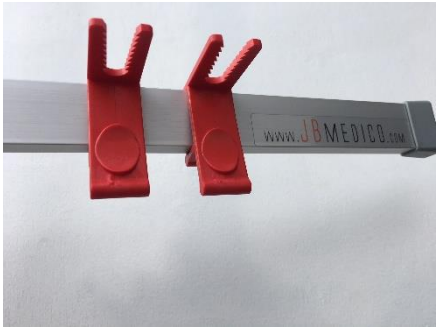
TUBING HOLDER

	Description	P/N	RRP EUR
	<p>TUBING HOLDER with guide for T-slots</p> <p>Made of aluminum</p> <p>Accessories: Clamp with T-tracks for EU-DIN 10x25mm standard rails</p>	<p>JB 292-00-00</p> <p>MOQ 5 PCS.</p> <p>JB 146-00-00</p>	
	<p>TUBING HOLDER for 10x25mm EU DIN bedside rails</p> <p>Made in red plastic</p> <p>Put directly on the rail</p> <p>Specifications: Depth: 40mm Height: 60mm</p>	<p>JB 600-10-25</p> <p>MOQ 10 PCS.</p>	
	<p>TUBING HOLDER for 10x30mm Scandinavian bedside rails.</p> <p>Made in red plastic</p> <p>Put directly on the rail</p> <p>Specifications: Depth: 40mm Height: 60mm</p>	<p>JB 600-00-01</p> <p>MOQ 10 PCS.</p>	

